

THE
SEWING MACHINE:

ITS HISTORY, CONSTRUCTION, AND APPLICATION.

TRANSLATED FROM THE GERMAN OF DR. HERZBERG

UPFIELD GREEN



ILLUSTRATED BY SEVEN PLATES.

LONDON.

E. AND F. N. SPON & BUCKLEBURY.

1854.

2335

FRANKLIN INSTITUTE LIBRARY
PHILADELPHIA

Class 687 Book H6445 Accession 2335

ARTICLE V.—The Library shall be divided into TWO CLASSES; the first comprising such work as, from their rarity or value, should not be lent out, all unbound periodicals, and such text books as ought to be found in a library of reference except when required by Committees of the Institute, or by members or holders of second class stock, who have obtained the sanction of the Committee. The second class shall include those books intended for circulation.

ARTICLE VI.—The Secretary shall have authority to loan to members and to holders of second class stock, any work belonging to the SECOND CLASS, subject to the following regulations.

Section 1.—No individual shall be permitted to have more than *two books* out at one time, without a written permission, signed by at least two members of the Library Committee, nor shall a book be kept out more than TWO WEEKS; but if no one has applied for it, the former borrower may renew the loan. Should any person have applied for it, the latter shall have the preference.

Section 2.—A FINE OF TEN CENTS PER WEEK shall be exacted for the detention of a book beyond the limited time; and if a book be not returned within three months it shall be deemed lost, and the borrower shall, in addition to his fines, forfeit its value.

Section 3.—Should any book be returned injured, the borrower shall pay for the injury, or replace the book, as the Library Committee may direct; and if one or more books, belonging to a set or sets, be lost, the borrower shall replace them or make full restitution.

ARTICLE VII.—Any person removing from the hall, without permission from the proper authorities, any book, newspaper or other property in charge of the Library Committee, shall be reported to the Committee, who may inflict any fine not exceeding twenty-five dollars.

ARTICLE VIII.—No member or holder of second class stock, whose annual contribution for the current year shall be unpaid or who is in arrears for fines, shall be entitled to the privileges of the Library or Reading Room.

ARTICLE IX.—If any member or holder of second class stock, shall refuse or neglect to comply with the foregoing rules, it shall be the duty of the Secretary to report him to the Committee on the Library.

ARTICLE X.—Any member or holder of second class stock, detected in mutilating the newspapers, pamphlets or books belonging to the Institute shall be deprived of his right of membership, and the name of the offender shall be made public.

687 H 445

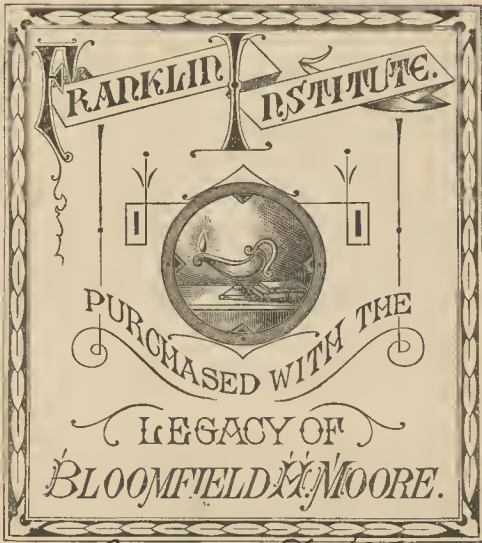

J. adv. act. 185.

THE
SEWING MACHINE:
ITS HISTORY,
CONSTRUCTION, AND APPLICATION.

TRANSLATED FROM THE GERMAN OF DR. HERZBERG.

BY

UPFIELD GREEN.



ILLUSTRATED BY SEVEN PLATES.



LONDON:
E. & F. N. SPON, 16, BUCKLERSBURY.
1864.

STANDARD LIBRARY

AMERICAN



CONTENTS.

	PAGE
I. THE FORMATION OF THE SEAM	1
A.—THE HAND SEAM	<i>ib.</i>
B.—THE VARIOUS DESCRIPTIONS OF MACHINE SEAMING	5
THE FORMATION OF THE STITCH	14
THE SINGLE-THREAD CHAIN-STITCH	19
THE RECIPROCATING HOOK	20
THE ROTATORY HOOK	21
2. THE DOUBLE-THREAD CHAIN-STITCH	23
THE QUILTING-STITCH	28
MACHINES WITH TRAVELLING SHUTTLE	<i>ib.</i>
SHUTTLES WITH HORIZONTAL RECTILINEAR MOTION	29
SHUTTLES FOR HORIZONTAL CURVILINEAR MOTION	34
SHUTTLES WITH VERTICAL CURVILINEAR MOTION	35
SHUTTLES WITH FIXED SPOOLS	37
II. THE MECHANICAL ARRANGEMENTS OF THE SEWING MACHINE	40
THE MECHANISM FOR COMMUNICATING MOTION TO THE NEEDLE	41
THE TRANSMISSION OF MOTION TO THE LOWER MECHANISM	46
1. THE REVOLVING HOOK	47
2. THE HOOK WITH RECIPROCATING MOTION	<i>ib.</i>
3. SHUTTLES WITH CURVILINEAR OSCILLATING MOTION	49
4. SHUTTLES WITH RECTILINEAR MOTION	54
5. LOOPER WITH LONG RECIPROCATING MOTION	55
THE MECHANISM FOR IMPARTING MOTION TO THE MATERIAL	<i>ib.</i>
I.—FEEDERS WORKING FROM BELOW	56
THE FEED WHEEL	61
II.—FEEDERS WORKING FROM ABOVE	64

	PAGE
THE STITCH REGULATOR	67
D.—THE TENSION APPARATUS	<i>ib.</i>
TENSION BY FRICTION OF THE THREAD	68
TENSION BY FRICTION ON THE SPOOL	<i>ib.</i>
TENSION BY A ROLLER	70
THE THREAD GUIDE	<i>ib.</i>
III.—THE SEWING MACHINE.	73
A.—THE MACHINES WITH OSCILLATING LOOPER FOR SINGLE-THREAD	
CHAIN-STITCH	77
THE SINGLE-THREAD CHAIN-STITCH MACHINE WITH ROTATING HOOK	84
MACHINES FOR DOUBLE-THREAD CHAIN-STITCH	86
D.—MACHINES FOR QUILTING-STITCH, WITH MOVEABLE SHUTTLES	92
1.—SINGER'S SYSTEM	93
2.—HOFMANN'S SYSTEM	99
3.—GROVER AND BAKER'S SYSTEM	102
THOMAS'S SYSTEM	105
THE QUILTING-STITCH MACHINE WITH FIXED BOBBIN	109

THE SEWING-MACHINE.

I. THE FORMATION OF THE SEAM.

A.—THE HAND SEAM.

THE seam, formed by hand, by means of a needle and thread, is generally intended to connect two pieces of material, either in a straight or curved direction. The construction of the seam itself varies according to the purpose of its application. The three principal varieties are: 1. *The tacking, or chain-stitch seam.* 2. *The whip, or overcast-stitch seam.* 3. *The quilting-stitch seam.* The latter description of seam (Plate II., Fig. 17) varies in appearance on each side of the material, as on the one side each stitch adjoins the other; while on the reverse, each stitch covers half of the preceding one. A variation of the quilting-stitch is the *back stitch* (Fig. 18), the derivation of which from the former is evident, by imagining between each two stitches a vacant space on the one side of the material of the length of a single stitch, causing each stitch on the other side only to cover a third of the preceding one. The whip-stitch seam consists of a series of stitches running spirally round the

edge of the material, close to the border of which the thread penetrates. In the tacking-stitch seam (Fig. 19), the thread runs alternately from one side of the material to the other, leaving on both sides a vacancy between each stitch. This stitch has the disadvantage of easily becoming undone, as the thread can be drawn through the material with great facility, owing to the small amount of friction. This peculiarity makes it, on the other hand, indispensable as a provisional method of fastening, the thread being again capable of use. For this purpose, the stitches on the one side are made long (1 to $1\frac{1}{2}$ in.), on the other side short ($\frac{1}{8}$ in.). From this application the stitch takes its name. This stitch has also the advantage of great elasticity, is quickly formed by hand, and is especially made use of in forming folds in dresses, &c. The whip stitch is employed in connecting the edges of two pieces of material, as it allows of their being drawn close together, without forming a perceptible elevation. It is mostly made use of for articles of clothing, the seams of which are in contact with the body, as shirts, gloves, &c.; or for such articles as are intended to appear seamless, as sheets, &c. There is more friction in this stitch between the material and the thread, and it is therefore much less liable to become unfastened. The quilting-stitch is the strongest, and also presents the best appearance. It is the most in use, and is indispensable in nearly all descriptions of needlework. The stitches are generally made very short on the surface of the work, and longer on the wrong side, and then answer the same purpose as the tacking stitch.

The first attempts which were made to accomplish

needlework by means of machines, were confined, as might be expected, to an exact imitation of sewing by hand. The process of gathering, especially in the manufacture of calico, was of sufficient importance to induce attempts at the construction of machinery to supersede manual labour. For this purpose an apparatus was for a long time in use, by which the calico in its passage between two fluted rollers was so folded as to allow of needles, which were fixed at various points of the extreme circumference of the rollers, penetrating several folds of the material at once. This arrangement underwent many modifications, and remained in use till its final displacement by the modern sewing-machine. The introduction of the needle with two points, and the eye in the centre, occurred in 1755, and was primarily intended to dispense with the continual inversion of the needle in sewing by hand. It was, however, soon employed in the construction of machines which were intended to imitate hand sewing, and nearly all machines which were constructed with this view, were on the principle of a double-pointed needle. The end of the thread was usually fastened to the eye in the centre, and the needle in its passage through the cloth was alternately drawn backwards and forwards by means of two grippers; the one above releasing its hold of the needle on the latter being caught by the gripper below. It was on this principle that the embroidering machine of Heilmann was constructed, which created so great a sensation at the time of its introduction, and in which several double-pointed needles were simultaneously in motion.

The construction of the so-called *cobbler's or saddler's*

seam, is somewhat similar (Plate VI., Fig. 19), being in reality only a double-tack stitch made by two threads crossing each other in their passage through the same needle-hole, so that the space left on either side between the stitches of each thread is covered by those of the other. Of course, a needle is required for each thread, and for these needles, two grippers are necessary on each side. The action of the grippers is, however, far from regular, which induced the construction of needles with a small barbed point, similar to those employed in crochet work. These penetrating the material without being drawn through caught the thread, and on their return drew it through the needle-hole. These needles could, therefore, be fastened to a holder, and their motion regulated with great certainty. To form the cobbler's *seam*, the two needles must work from opposite sides of the material, the holes in which may, in the case of very tough materials, as leather, be made by a stiletto-like instrument, to prevent injury to the needles. This description of machine has not, however, found much favour; and, in fact, all machines in which hand sewing is attempted to be imitated, whether with double or hook-pointed needles, whether forming tack, whip, or quilting-stitch, are of but small practical importance. In sewing by hand, the thread cannot be used of a greater length than the distance the hand can be stretched from the material to be sewn. The length of thread must always remain very limited, and the consequent frequent interruption in the work causes both delay and hindrance. This disadvantage has, in machines imitating hand sewing, up to the present not been removed, and should even this imperfection be surmounted,

two still greater difficulties would present themselves, as the thread becomes much worn from its constant passage through the material, and each stitch requires much time in its formation.

B.—THE VARIOUS DESCRIPTIONS OF MACHINE SEAMING.

It having been soon perceived that the imitation of hand sewing by machines was attended by difficulties so great as to be almost insurmountable, induced the discovery of some other description of stitch which could be more easily effected by a machine, and which should both possess the most valuable peculiarity of the whip and quilting-stitches in not being liable to come undone, and also allow of the use of a thread at least some yards long. One of the best of such seams formed by a single thread is shown, Plate VI., Figs. 22 and 23. The second of these differs from the first only through the thread of the loops on the under side of the material being twisted half round. Another seam varying but slightly from the preceding is shown in Fig. 24. Its appearance is not so fine and regular as that of the others owing to the spaces left between the stitches, and requires nearly the same quantity of thread. Its advantage consists in a smoother join on the wrong side of the material. But few of such machines have, however, been constructed and come into use; still less such machines as are intended to produce the seams described below, and for which a double thread is required. It is true they produce a seam which cannot come undone, and show on the surface a plain smooth series of stitches, but the mechanical arrangements are so complicated that there is but small probability of their coming into

general use. Fig. 20 shows a description of quilting-stitch with a knot in the lower side, which forms a heavy ridge, and has a very irregular appearance. This is in a less degree the ease in the seam shown in Fig. 25, in which the loops on the lower side are more simple, and the knots not so thick, while in that shown in Fig. 26, the bottom thread simply connects the loops of the top thread by means of a knot. The only practical permanent machine stitch is the so-called machine quilting-stitch, which is also formed by a double thread, and which we shall in future simply call the quilting-stitch. A very similar one, but formed by a treble thread, is represented in Fig. 21, in which the lower side is also shown. On account of the inconveniences attaching to it, it is but seldom employed.

The seams which have been enumerated have been styled permanent. By this is not intended to be said that they cannot be undone, but that by simply pulling the ends of the thread the seam does not rip without the thread breaking. A permanent seam has therefore the peculiarity of remaining perfectly secure and lasting, even if here and there a stitch should be broken or the thread worn.

Other descriptions of seams may be divided into such as are easily and such as are with difficulty undone. The latter remain perfect if only the *end* of the thread, or the end of *one* thread of such as are formed by a double or treble thread, is pulled. Of these the stitch invented by Grover and Baker, a description of which will be given later, deserves the preference. A somewhat similar stitch formed by needles passing diagonally through the material, which is thereby much

weakened, is shown in Fig. 27. The stitch shown in Fig. 28, belongs also to this category, is simple and lasting, consumes but little thread, and presents a very good appearance, but the mechanism by which it is produced does not possess the necessary simplicity and certainty. The same fault attaches to the stitch shown in Fig. 30, which is also distinguished by durability, elasticity, and appearance. It possesses the peculiarity of allowing two needles to work, one within the other, on the same side of the material, and has therefore been applied to fastening the soles of boots to the uppers. Fig. 31 can hardly be said to belong to this category, being formed by two threads, the end of one of which being pulled allows the seam to become unravelled, while the other does not allow of it. No advantage is attached to this stitch, as it consumes much thread, weakens the material, and has neither a smooth nor even appearance. It may be considered as the transition to the class of seams which may be readily undone, the type of which is the simple chain or tambour-stitch. This is the third description of stitch which has been extensively practically employed, and will, therefore, be specially treated of later. The following descriptions may also be noticed, though partly on account of the difficulty and uncertainty attending their formation, partly on account of their inferiority to the chain-stitch in simplicity, appearance, and consumption of thread, they have scarcely any practical importance. Fig. 29 shows, as do all seams of this description, on the one side a line of even stitches, and on the other a row of interlocked loops consuming a large quantity of thread, and presenting a very heavy appearance. Fig.

36 differs from Fig. 37, inasmuch as the loop of the chain on the lower side is apparently knotted in each stitch in the former, and only in every other stitch in the latter. Figs. 38 and 39 also show a series of loops interlocked in each stitch, without being on that account any more durable than the simple chain-stitch. We may here mention Singer's chain-stitch machine, which created so great a sensation at the time of its appearance at the Paris Exhibition, on account of its forming a knot to every seven chain-stitches, although this did not in any way increase the durability of the seam.

There remain only to be mentioned two descriptions of seam intended to take the place of the whip-stitch in hand sewing, whether this is intended to connect the edges of two pieces of material, or to sew round the edges of the material in order to prevent it fraying, as in button-holes, &c. Seams for the first purpose, produced by a double thread, are shown in Figs. 32, 33, and 34. They are all modifications of the quilting-stitch, produced by an alteration in the direction of the stitches. Fig. 32 deserves, on account of its simplicity and regularity, the preference. The seam, Fig. 35, may be considered as valueless, owing to the employment of five threads.

In the whip-stitch, or button-hole machine stitch, the same distinction of durability exists. The button-hole stitch represented in Fig. 42, which is a modified quilting-stitch, and might be produced on a common quilting-stitch machine with a slight mechanical alteration, belongs to the permanent class, while Fig. 43 shows one of those that are with difficulty unravelled. It is

also formed by a double thread, and is a slightly varied imitation of the Grover and Baker stitch. In Figs. 40 and 41, two button-hole stitches, which can be easily undone, are represented, and may be considered as a modification of the simple chain-stitch, being formed similarly to this with a single thread.

Much attention has been paid to the construction of so-called button-hole machines, the process of making button-holes by hand being both tedious and time consuming. All attempts, however, to construct a practical button-hole machine have hitherto failed, and we are thus induced to consider the causes of the non-success of these endeavours. The needles which are employed for sewing-machines are very thick compared with those for sewing by hand, for reasons which will be explained hereafter. In making button-holes in stout and firm materials, which are best suited for this description of work, the needle penetrates the material close to its edge, and the large holes made by the needle in its passage frequently cause the material to tear and the seam to rip. On the other hand, soft materials, which would not suffer from this cause, cannot be well sewn on a whip-stitch machine on account of their pliability and the rottenness of their edges.

In reality, the only three seams which have hitherto met with extensive practical application, are the simple chain-stitch, the Grover and Baker stitch, and the quilting-stitch seams. Though not all possessing the same degree of durability, they have all the important property of being produced without frequent interruptions and delays from the replacement of the thread consumed. The formation of the stitches of these seams

also fulfils the condition, that the thread should return through the same hole through which it has been passed by the needle. A loop is therefore formed on the lower side of the material, and is fastened in various manners, according to the description of seam. The loop is either fastened by the succeeding one passing through it (Plate I. Fig. 17), or a second thread is specially employed for this purpose, which, having passed through the loop, again returns through it, forming a second loop, which is itself fastened by the following stitch (Fig. 18); or sometimes the second thread runs through the loops for the entire length of the seam. At first sight, a similar inconvenience to that found in hand sewing, would appear to arise, viz.—that the whole length of the second thread must be drawn through the loops of the first at every stitch; but these loops may be readily made to admit of the passage of a bobbin on which the thread is wound.

The first of the seams described in detail above, and which is formed by a single thread only, is called the single-thread chain-stitch, or tambour-stitch seam, and each stitch of it is called a single-thread chain, or tambour-stitch. The second, formed by two threads, is called the double-thread chain-stitch seam; or, after its inventors, the Grover and Baker stitch seam; and each stitch, the double-thread chain-stitch, or Grover and Baker stitch. The third, which is also formed by a double thread, is called the quilting-stitch seam; and a single stitch, the quilting-stitch.

The tambour-stitch seam, which is the simplest of the three, has the advantage over the others of simplicity of construction, from the fact of one thread only being

employed. The seam requires about $3\frac{1}{2}$ to 4 times its own length of thread, which proportion is somewhat increased if the stitches are made small, or if the material is unusually thick. It easily comes undone, and a single imperfect stitch, C (Plate I., Fig. 17), may cause the failure of the whole seam. Such an imperfect stitch may be caused by the loop of a stitch not being caught by the succeeding one. This is the principal defect of the tambour-stitch, and it is on this account but seldom employed when strength and durability are required. It has been employed for sewing sacks, &c., and when perfect, has been found, from its great elasticity, to be as durable as hand sewing. In calico factories it is nearly always employed for connecting the pieces, and has answered exceedingly well, even when only cotton thread is employed. Its principal application is, however, to ornamental work, for which both the upper and lower surfaces of the stitch are made use of. The upper for sewing cap-linings, mantles, ties, &c., the lower for these articles also, but more particularly in the manufacture of gloves.

The double-thread chain-stitch is, in almost every respect, the transition from the tambour-stitch to the quilting-stitch. Its upper surface resembles in appearance the former; its lower surface presenting a kind of chain, composed of two threads. It requires 5 to 6 times its own length of thread (according to the thickness of the material, and the distance of the stitches apart). This large consumption of thread is a great drawback, especially when silk thread has to be employed. In this case, however, common cotton is generally employed for the lower thread, so that the cost of the double-thread

chain-stitch is not greater than that of the single-thread chain-stitch in silk only. The former is also infinitely to be preferred to the latter where durability is required; as although in the ease of a stitch being dropped, it would be possible to unravel that portion of the seam which was already completed, the seam seldom comes undone through wear alone of the article sewn. An imperfect stitch may occur in two ways; either the loop of the lower thread *c* (Plate I., Fig. 18) is not caught by the succeeding one of the upper thread, in which case the seam would not of itself come undone, the loop *e* being held by the loop *c*, which is again held by the loop *e*, being tightly drawn together; or the loop of the upper thread *b* is not caught by the succeeding one of the lower thread *f*, and in this case the loop *b* would be entirely drawn out of the material by the tension of the upper thread, as would also the loop *f* by that of the lower thread causing the stitch *g h* double the length of the other stitches, and containing the same imperfect stitch *d*, already described, which does not involve a further unravelling of the seam. The double-thread chain-stitch can, therefore, very well be applied where durability and strength are required for articles of dress, caps, cloth boots, gloves, &c.; it is also frequently made use of in sewing stays, both for its appearance and strength. The lower side is generally employed in the decoration of mantles, caps, ties, gloves, &c., as from the employment of two threads, a variety in colour may be produced, as may also the effect of braiding by taking the lower thread of sufficient thickness, and allowing the tension to be as slight as possible. The thickness of the seam on the wrong side, which causes

articles of dress to wear soon out at the point of connexion, is diminished by using very fine cotton for the lower thread, so that the chain has almost the appearance of a single thread.

The quilting seam is the most perfect which can be produced by the sewing-machine. The advantages of the single and double-thread chain-stitch, are retained without their inconveniences. It is true that should the lower thread, which passes through all the loops of the upper one, be drawn out, the whole seam would become unravelled. But we are enabled, by means of the loops of the upper thread, to draw the lower thread into the material to be sewn, when the seam presents the appearance shown (Plate II., Fig. 16 to the right-hand side), which is the true machine quilting, or back-stitch seam, that can no longer come undone. This further advantage is also gained, that the seam is alike on both sides. An imperfect stitch can also occur in this description of seam, from the lower thread not passing through the loop formed by the upper one, which is then drawn back out of the material, causing a stitch double the length of the others, without in any way impairing the durability of the seam. The thread consumed by this description of seam is proportionately small, about $2\frac{1}{2}$ times the length of the seam itself. The stitches being moderately long, and the material not too stout, the proportion of thread consumed by quilting, single and double-thread chain-stitch seams, may be taken as 2, 3, 4. Another quality in favour of the quilting-stitch. This stitch is, therefore, the most extensively employed, both for ornamental and durable work—for shirts, coats, dresses, caps, gloves, stays, shoes, saddles, in fact, for every

description of sewing. These seams are all fastened off by enlarging the last loop of the upper thread, drawing it through the needle-hole, and tying it to the lower thread. In the quilting-stitch seam, 3 or 4 stitches backward answer the same purpose.

THE FORMATION OF THE STITCH.

The needle employed in machine sewing differs from that employed in sewing by hand, as instead of having the eye at the head of the needle, it is constructed close to the point. The machine needle consists, therefore, of a short conical point and a long cylindrical body. The point must not be too stout, as it would otherwise meet with too much resistance in its passage through leather, pasteboard, &c. A special apparatus for piercing the holes for the passage of the needles is no longer employed, and the needles are now constructed angular, with two, three, or four sides for heavy work. The two-edged needle has, perhaps, come most into use, the flat sides of which have a direction diagonal to that of the seam, and the stitches also have this direction, so that the seam resembles the saddler's seam (Fig. 23). The length of the point of the needle (reckoning from the eye) varies from $\frac{1}{8}$ to $\frac{1}{4}$ in. Circumstances at times require a longer or shorter point, but as a rule, short points are to be preferred, as a long point requires a longer stroke of the needle, which is disadvantageous in a machine which is required to work with rapidity. On the other hand, long points have the advantage of allowing of their being re-ground when blunt. The eye of the needle is a cylindrical hole, the outer edges of which are rounded off. It is important that the interior sur-

face of the eye should be perfectly smooth, so that the thread, which does not as in hand sewing retain a fixed position in the eye, but passes backwards and forwards in it at each stitch, should not become frayed by the constant friction, and at last break. The eye must also on this account be made proportionately large, and its edges rounded off, giving to it the appearance of being conically enlarged on each side. Fig. 24, in Plate II., shows a perfectly cylindrical eye (*f*) on an enlarged scale, in which the thread evidently suffers more from friction than in the conically enlarged eye (*c*).

The eye being larger in proportion to the thread than that of the common sewing needle, and the size of the body of the needle being conditional on the size of the eye, the exterior of which must be made sufficiently stout as not to weaken the needle, it follows that for thread of a given thickness a stouter needle must be employed in machine than in hand sewing. Owing to this the hole made by the needle is too large in proportion to the thickness of the thread, which though unimportant for soft materials, as cloth, silk, cotton goods, &c., is a great objection when the material is tough and hard, as leather. Especially when the stitches are very small the material is apt to rip in the direction of the seam. In the seam made by shoemakers, by means of an awl, the thread not only entirely occupies the space made by the awl, but is actually compressed into the puncture, while the thread of a machine-made seam has always more or less play in the hole made by the needle. In order to assist the passage of the needle, with the thread on each side of it, through the material, the needle is grooved on both sides from the eye as far as

the needle penetrates. The length of this groove is from 7 to 11^m, according to the construction of the machine. The depth depends naturally on the stoutness of the needle, but is always made as deep as possible without impairing the strength of the needle. Sometimes the groove is continued on towards the point $\frac{1}{12}$ to $\frac{1}{3}$ ^m, as on the withdrawal of the needle from the material the thread lies close to the needle in the direction of the point. (See Fig. 21, *a e.*)

The needle is affixed to the so-called *needle carrier*, the distance of the eye from which varies according to the construction of the machine. As a rule, the distance should be as short as possible, never exceeding 1 in., except in machines in which very stout needles are employed, as the shorter the needle the greater strength it possesses. That part of the needle fitting into the needle carrier is generally somewhat thicker than the rest, and is made of the same thickness for needles of all dimensions. This arrangement imparts greater strength to thin needles, and also allows both thick and thin needles to be so inserted that the points of either move up and down in a certain fixed straight line. Many needles are, however, made without being thus strengthened, owing to their greater cost, whether constructed of one piece or with a shank soldered on. The steel of which the needles are manufactured must not be so hard as to allow of their easily breaking, but must possess sufficient elasticity to prevent their becoming bent. The shank only, which is inserted in the needle carrier, is usually made softer. The thickness of the needles varies from $\frac{1}{64}$ to $\frac{1}{12}$ in., according to the description of thread

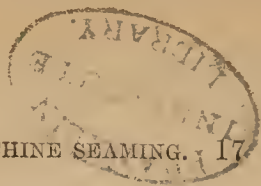

and material. The finest needles would break even with thin leather.

The needle having pierced through the material with the thread drawn tightly in the grooves on either side, and commencing to ascend, the thread is retained in the material by friction, and being lifted by the eye of the needle, assumes the form of a loop (*a*, Plate II., Fig. 25), which is then caught by a pointed instrument for the purpose of completing the stitch. If the needle is similarly constructed on both sides, equal sized loops will be formed on each side, and therefore the groove on that side of the needle where the loop is intended to be formed is made shorter than on the other (*a b*, Fig. 21), causing the thread to have a tendency to more readily leave the needle on this side, and to form the loop A and B, Fig. 25. Such needles as are made with grooves equally long on both sides more frequently make an imperfect loop, involving often an imperfect stitch.

The thread employed must be pliant, flexible, and soft. If stiff and hard thread is employed a bend (*c*, Fig. 25) is caused by the eye of the needle which prevents the formation of the loop. Sewing-machine thread must therefore not be stiff, thus excluding the use of wax, pitch, &c. Silk is better than cotton, and this again better than linen thread. Another requisite of good thread is evenness. If the thickness of the thread varies frequently and suddenly, the loops formed at such parts are generally imperfect. Machine thread must also be twisted more than common thread. Too great a twist, however, causes it to kink, which is also to be avoided. It is evident from the foregoing, that

common sewing-thread cannot with advantage be employed. The finish alone of ordinary thread involves stiffness and a want of pliability.

Some time elapsed before the idea of forming the loop by a short upward motion of the needle was adopted. At first a semi-circular form was given to the needle just above the eye, and above this curve a second eye, both eyes being connected on the exterior periphery of the curve by a groove in which the thread ran, and by which the bend necessary for the formation of the loop was caused. The objections to this arrangement are evident. After the introduction of the straight needle, a kind of gripper was invented to catch the thread on that side of the needle where the loop was intended to be formed, but this arrangement has also been discarded.

As the first requisite in a sewing-machine is certainty in the formation of the loop, the height to which the needle must rise before the mechanism intended to catch the loop can commence its action is important. As, however, silk more easily forms a loop than cotton, and this again than linen thread, and as the shape of the loop should be adapted to the point by which it is intended to be caught, this height should also vary according to the circumstances. But this would involve a complication of the mechanism, and a distance of $\frac{1}{4}$ to $\frac{1}{8}$ in. has been adopted, generally $\frac{1}{8}$, $\frac{1}{12}$ in. not being sufficient for thread of inferior quality.

After the formation of the loop the mechanism situated below the material, and which is intended to perfect the stitch, comes into play. The arrangement

of this varies according to the description of seam intended.

THE SINGLE-THREAD CHAIN-STITCH.

The needle with a hook point, first introduced by Thimonnier, a Frenchman, in 1830, for the purpose of forming the chain-stitch, has given rise to the most varied constructions of tambour-stitch machines. In the machine originally constructed by Thimonnier, the crochet needle works from above, while below the material the thread is conveyed from a spindle by means of the so-called thread carrier to the hook of the needle, which conveys it upwards as a loop passing the loop of the previously formed stitch. The chain is thus formed on the upper side of the material, while in the machines of a later construction it is on the lower side, the needle working from below and having a reciprocating motion, which not only dispenses with a special arrangement for propelling the material, but permits of the reel conveying the thread being a fixture, the thread being caught by the hook alone. The American Singer, a German by birth, introduced in 1854 a new principle, which is still in use. His machine has on the one side an eye-pointed needle, and a reciprocating hook or looper on the other. A closer examination of the motion of this hook shows that it consists of two motions, one perpendicular to the other. These two motions have also been given to two separate hooks working together, which at the same moment hold open the loop of the thread. Another inventor has dispensed with the horizontal vibratory motion, and introduced a perpendicular one; another causes the needle to vibrate,

making the hook a fixture; and a third causes the hook, which is affixed to a spring, to be pushed aside by the needle in its descent. Another has introduced an eye-pointed needle on the one side, and a hook-pointed needle, by which the thread is caught and retained till the descent of the upper needle, on the lower side. Machines constructed on this system are still in use, one of which is delineated in Plate I.; but they are being gradually displaced by more practical ones, constructed on the system introduced by James Wilcox, in 1860. A machine of this description is represented in Plate II.

THE RECIPROCATING HOOK

consists merely of a conical point (*b c*, Fig. 21, Plate I.) with a triangular base, *B*. The point forms therefore a three-sided equilateral pyramid. The surface *d b* lies horizontal, the surface *d c* perpendicular, so that the latter during the motion of the hook from left to right, and right to left, passes close to the needle. Fig. 19, *A*, represents the hook in its extreme position to the right, *C*, *D*, and *E* in its extreme left. In the first position it is about $\frac{1}{8}$ to $\frac{1}{12}$ in. distant from the needle, and is calculated to arrive at this position when the needle has reached its deepest point. The needle having risen about $\frac{1}{8}$ to $\frac{1}{12}$ in., so as to form the loop, the hook has moved so far from the right to the left that its point almost touches the needle, being about $\frac{1}{12}$ in. above the eye, or just at the widest point of the loop, Fig. 19, *B*. The needle rising still farther, the hook continues its motion to the left, catches the loop and holds it in that position, *C*, till the needle is withdrawn from the material and reaches its highest position. At this moment the material to be

sewn is moved the distance of a stitch in a direction contrary to that of the hook and the needle, and the needle in its descent penetrates through into the loop E. To ensure this the hook, after reaching its extreme position on the left, moves in a direction perpendicular to its former one as indicated by the arrow, Fig. 21, A. The loop held by the hook becoming narrower towards the left, it is necessary for the needle to pass as close as possible behind the hook, the back of which, *e*, is therefore sometimes hollowed out (the hollow, *e f*, decreasing downwards) in order to allow the needle to come close to the foremost end of the loop. Directly the needle has caught the loop the hook is thrown back so quickly that the back part of it passes $\frac{1}{16}$ to $\frac{1}{12}$ in. below the eye of the needle, as it would otherwise in passing so close to the needle fray and injure the thread. The backward motion of the hook must therefore be very rapid, and as it is of advantage that all the motions of a machine should be as slow and small as possible, it follows that the point of the needle should be as long, the hook as short, as possible. The needles for these machines are therefore generally made with a point of $\frac{1}{4}$ in. and more. The projecting point of the hook $\frac{3}{16}$ in., or, reckoning to the hollow before mentioned, $\frac{5}{16}$ in.

THE ROTATORY HOOK.

We have now to consider a rotatory hook, which catches the loop and holds it till the needle in making the succeeding stitch has descended and passed the loop. In this instance, also, the needle is calculated to have risen $\frac{1}{2}$ in. at the moment of the hook, which is

of a very pointed shape, passing $\frac{1}{12}$ in. behind the needle, and catching the loop, which has just been formed. Fig. 8, Plate II., shows the shape of the hook. From a front view, A, its motion is in a contrary direction to that of the hand of a watch. B presents the reverse side. Taken at the moment when its point is directed upward, C gives its appearance from below, D from the left, E from above, and F from the right. It consists of two parts diametrically opposite to each other, viz. the curved catch for retaining the loop, and the cast off, having an inclination towards the axis of the hook, which is intended to throw off the loops for the completion of the stitch. The cast off is affixed with its smaller side, $\alpha\beta\gamma\delta$, the sides of which are almost radial to one another, to a disc attached to the square of the axis of the hook. The needle having risen sufficiently to allow of the formation of the loop, the catch has advanced so far to the left that its point passes close to the needle (Fig. 15, A), which shows also the release of the previous loop. Continuing its motion to the left, it penetrates the loop as shown in B, and commences to move towards the right at the moment the needle has completed its ascent, C. The material is now moved from right to left the length of a stitch, which movement is accomplished just previous to the needle again penetrating it. The cast off has in the mean time advanced from a horizontal to a perpendicular position, D, and the front thread has slipped down the inclined side off the same; the hinder thread is now caught by the other side of the cast off, E, and is thus inclined forward, while the thread which was previously in front is now behind, and the loop, having made half

a turn on its axis, now lies in a hollow, $\epsilon\beta$, Fig. 8, C, formed by the junction of the catch and cast off, in which it is retained till the catch having penetrated the new loop, it is released and drawn tight by the tension of the thread. The needle having in its descent passed through the old loop, has commenced to rise at the moment of this being released, but is still in a position to catch and retain it. Were the old loop to be released before the entrance of the catch into the new one, it might happen to be again caught, and carried round with the new one, which would inevitably cause a breakage of the thread. The point of the needle would also in this case be made as long as possible, in order to make more certain of its catching the loop, were it not that in its descent it would certainly strike the steel hook and break. This would even be the case with a point $\frac{1}{8}$ in. in length, such as is commonly used with these machines, were the hook not provided with a groove, γ , Fig. 8, E, at this point. From this description it will be perceived that the loops on the lower side of the seam have a twist of 180° , which constitutes the difference between the stitch formed in this manner, and that formed by the reciprocating hook.

2. THE DOUBLE-THREAD CHAIN STITCH.

The hook which catches the loop on the ascent of the needle is in this case also intended to carry a second thread through the loop of the upper one in such a manner that the former also forms a loop, which is caught by the needle in its descent passing through it. For this purpose its shape is somewhat altered. Fig. 22, Plate I., delineates it in A from above, B from behind,

C from the front, D from the left, and E from the right. It is longer than that for the tambour-stitch, and ends like it in a point, its front flat surface passing close to the needle to ensure catching the loop. The hook cannot in this case be so pointed, as it has also to convey a second thread, which passes through a hole drilled in it from the back to the front. This hole must allow of the thread intended for the lower chain passing freely through it; $\frac{1}{2}$ " is generally taken. The thread before entering this eye runs in a groove passing horizontally along the exterior side of the hook, and continues through another hole drilled in the back of the hook, to the reel supplying it. In the passage of the hook through the loop of the upper thread, this must of course slide along the groove over the lower thread, and the groove is for the purpose of protecting the lower thread, and preventing unnecessary friction and fraying of both threads. Fig. 20, A, shows the hook in its extreme position to the right with the point about $\frac{1}{8}$ in. from the needle. The construction is in this instance, also, such that this position occurs at the moment of the needle reaching its lowest point. The needle having risen sufficiently, about $\frac{1}{2}$ in., to allow of the formation of the loop, the hook has advanced so far from right to left, that its point is close to the needle (B), about $\frac{1}{12}$ to $\frac{1}{8}$ in. from the eye. The needle continuing its ascent, the hook still advances and retains the loop in its extreme position to the left (C). At the moment of the needle completing its ascent, the material commences to move in a contrary direction to that of the hook, the distance of a stitch, and com-

pletes this movement before it is again reached by the point of the needle. The needle now in its descent reaches the loop of the lower thread below the material (E), but without in this case passing through the loop of the upper thread. It is on this account that the hook is made longer and thinner, so as to allow of its passage through the loop without carrying it forward. To ensure the needle passing through the loop of the lower thread, the hook must in this instance also, on reaching its extreme position to the left, make a slight lateral motion perpendicular to the previous one *c* (Fig. 22). The loop itself affords a free passage to the needle, owing to the hook being hollowed out a little at the point of descent of the needle. The loop being caught by the needle, the hook is thrown back so quickly that the back part of it passes under the needle. The point of the needle is generally $\frac{1}{4}$ in. long, the size of the looper is shown, Fig. 22.

Attempts have been frequently made to construct the looper so as to allow of its application both to the single and double-thread chain-stitch. A steel piece, *l*, is screwed on to the looper (Fig. 22, F, Plate I.), which is employed for the double-thread stitch, or a steel wire is passed through the holes drilled in the looper, but both these methods require the hook to be longer than usual from the point to the first hole, so that it is almost as long as that of the tambour-stitch looper, $\frac{3}{16}$ in. A separate looper for each description of work is, however, preferable, but it does not on the whole appear advantageous, as will be shown later, to employ the same machine for two descriptions of sewing.

The double-thread chain-stitch looper has also undergone several modifications. It has been replaced by a simple eye-pointed needle with a horizontal to-and-fro motion, carrying the second thread, and forming like the upper needle a loop by a slight side motion on the completion of its stroke. Grover and Baker's modification of the double-chain-stitch (Plate III., Fig. 14), originated from the needle having a curved shape given to it.

The needle by its ascent causes a loop, which is caught and held by the hook till the needle on its return has caught the loop of the lower thread. This description of double-chain-stitch hook differs but slightly from the above-described looper; it has a point to catch the loop, and this point is also bored to allow of the passage of the lower thread, which is conveyed to the point in a groove on the outer surface of the hook. The hook is almost circular, and vibrates on its axis horizontally about 180° right and left. The radius of its inner curve, $ag h$ (Fig. 14, A, Plate III.), increases gradually from the point $\frac{1}{16}$ to $\frac{1}{2}$ in., so that it is only the point which passes close to the needle, the hind part leaving the above space between it and the needle. The drawings show the correct form and proportions of the hook, which are seldom deviated from by the makers. A line drawn from the point of the hook to the centre, is calculated to fall perpendicularly on the radial piece, ef , which is, therefore, parallel with the direction of the point of the hook. From the point to the eye is about $\frac{1}{8}$ in., and the eye itself, as in the other hook, $\frac{1}{2}$ ". The groove running round the extreme periphery from the eye, has a section of $\frac{1}{2}$ " — $\frac{1}{16}$ " breadth

and depth. The hinder part of the hook, *d*, is filed flat, and also bored through in the direction *d e*. The thread running from a spindle passes through the opening along the groove, which is covered at the point *c* to prevent the thread leaving it, and then through the eye at the point. Both the axis and the hook itself are $\frac{1}{8}$ in. thick.

Fig. 14, A and B, show the hook in its extreme left position, in which its point is distant about $\frac{1}{8}$ in. from the needle. It is in this position when the needle has completed its descent, and remains so till the needle by its ascent has almost completed the loop, so that its point on its return reaches the needle at the moment of the completion of the loop. For reasons which will be explained hereafter, the loop is not complete till the needle has risen $\frac{3}{8}$ in. At this moment the point of the hook is still $\frac{1}{2}$ in. above the eye of the needle (Fig. 14, C.). The needle continuing its ascent, the hook advances into the loop of the upper thread, and reaches its extreme position, right, at the moment of the eye of the needle leaving the material (Fig. 14, E.). The hook commences its return when, on the descent of the needle, the eye has again reached the material. The loop of the upper thread is drawn somewhat on one side of the hook, so that the needle in its descent penetrates the loop, *m n o p*, Fig. 14, F, of the lower thread formed by the return motion of the hook, similarly to the side motion of the needle, and still retains it when the hook has finished its return. The material, of course, also in this instance, is advanced the length of a stitch at the moment of the needle commencing its descent. Fig. 14, A to F, shows the various positions of the hook from

above and below. A further but unimportant variation of the Grover and Baker looper has been attempted by making the axis horizontal, the principle remaining the same.

The question naturally arises, whether a looper might not also be constructed for the double-chain-stitch having a constant rotary, instead of an intermittent vibratory motion. The possibility is granted; but one difficulty arises to prevent the introduction of such a looper, which is this: The lower thread would, before entering the hole drilled in the looper, have to pass through the axis of the shaft of the looper, which would much increase the difficulties attending the construction of such a machine.

THE QUILTING-STITCH

is formed by the entire length of the lower thread passing through the loops of the upper thread formed by the ascent of the needle. For this purpose the lower thread is wound on a reel, which, passing through the loop, carries the thread with it. But as the loop is not sufficiently large to allow of the passage of the bobbin, it must first be enlarged, which is accomplished either by enclosing the bobbin or spool in a shuttle running to a point, and gradually increasing in size, or a catch is constructed, by which the loop is lengthened and drawn over the bobbin, which in this case remains stationary. The quilting-stitch machines may thus be divided into those with travelling shuttle, and those with a stationary bobbin.

MACHINES WITH TRAVELLING SHUTTLE.

Walter Hunt was the original inventor of this com-

combination of the eye-pointed needle and travelling shuttle. The shuttle has naturally from time to time been improved upon and altered in form, but the peculiarities of a point by which the loop is caught, and the being made as narrow as possible consistently with carrying the bobbin, have always remained the same. Both the point and the body of the shuttle must pass as close as possible to the needle, to avoid the necessity of too great an enlargement of the loop. The shuttles travel either in a straight or curved line, in some cases horizontally, in others perpendicularly. There are, therefore, three distinct descriptions of shuttles. First, those having rectilinear motion; next, those with a perpendicular curvilinear motion; and, lastly, those with a horizontal curvilinear motion. The old and impracticable arrangement may also be noticed, in which the shuttle has a continuous circular motion.

SHUTTLES WITH HORIZONTAL RECTILINEAR MOTION.

To ascertain their correct form we must examine the manner of their application. The one side of the shuttle generally fits close to a perpendicular surface, in which a groove runs perpendicularly for the passage of the needle up and down, passing therefore close to the latter. Fig. 26, Plate II., shows the exterior of the shuttle. The shuttle is also sometimes constructed with a point at either end, so that in its passage both backwards and forwards it traverses a loop of the upper thread, thus completing two stitches. In Fig. 22, Plate IV., where the various relative positions of the needle and shuttle are shown, the shuttle is assumed to pass from

left to right behind the needle so as to afford a view of its interior. This is usually the arrangement, although the direction is immaterial in principle. For a shuttle passing behind the needle the motion must be from right to left. The needle having reached its deepest point, the shuttle has arrived at its extreme position, left, Fig. 22, E, and its point is there $\frac{3}{16}$ to $\frac{1}{4}$ in. distant from the needle; some manufacturers, however, leave but $\frac{1}{8}$ to $\frac{1}{12}$ in. The shuttle now commences its motion from left to right, and reaches with its point the needle at the moment of the completion of the loop, Fig. 22, A. In machines with travelling shuttles in which thread is generally employed, the ascent of the needle, necessary for the formation of the loop, is mostly made longer than usual, about $\frac{1}{8}$ in. The eye of the needle is also arranged to be about $\frac{1}{8}$ in. from the point of the shuttle, as the widest part of the loop falls somewhat higher than usual, owing to the increased loop forming ascent of the needle. Were the ascent of the needle now to be continued, or were it to remain stationary, the lower edge of the shuttle would, in passing the eye of the needle, be liable to fray or break the thread. The needle is therefore allowed to again descend so far as to allow of the eye continuing below the shuttle (Fig. 22, B) till the hinder part of the latter has reached the needle (Fig. 22, C). The needle then again commences its ascent, the shuttle remaining stationary till the upper thread has been drawn back sufficiently (Fig. 22, D) to allow of the return of the shuttle without the latter coming in contact with the loop. The return of the shuttle to its extreme left occupies the time necessary for the completion of the ascent and descent of the needle, and while the

needle is at its highest point of ascent, the material is moved forward the length of a stitch.

In the above construction of the shuttle an intermittent motion is necessary, which prevents the application of the common treadle and crank. By lengthening the heel of the shuttle, so as to allow the motion of the shuttle to the right to be continued till the needle has ascended sufficiently to allow of its free return, we are enabled to apply the crank motion, particularly as this possesses the peculiarity of retarding its motion at the moment of turning the centre.

Attempts have also been made to simplify the motion of the needle. As before described, the needle on the completion of the loop must again descend so as to allow of its eye being below the lower edge of the shuttle during the side motion of the latter. This can be avoided by so arranging that the eye of the needle, at the moment of the completion of the loop, is already below the shuttle, Plate IV., Fig. 22, A. The point of the shuttle must in this case be bent downwards, so that the requisite distance, as before mentioned, still continues between it and the eye of the needle. The surface of the shuttle must be perfectly smooth and polished to allow of the thread slipping freely over it. It is constructed of steel of about $\frac{1}{24}$ to $\frac{1}{16}$ in. thick. The thinner it is, the more room in the interior, the larger the bobbin can be, and the longer a thread can be carried. The bobbin consists of a steel axis, *a b*, Fig. 28, Plate II., the ends of which *a* and *b* are hardened, and to which two round discs are affixed, between which the thread is wound. These discs are rounded off on their interior surface, so that in winding the thread each

layer may lie evenly on the preceding one. The pivots of the bobbin run in two sockets, one of which is drilled in a small piece of steel brazed to the front end of the shuttle, the other in a sliding piece which is pressed forward by a spiral spring. The hinder pivot of the bobbin is first introduced into *e*, and the other then slides in a groove into the other socket. The bobbin is thus prevented from shifting longitudinally, and can at the same time revolve freely without much friction. The sliding piece has also been inserted in the front part of the shuttle, Fig. 29, which arrangement allows of the bobbin being made longer, and has therefore mostly been adopted. The shuttle is also generally furnished with a cover, but this is unnecessary as long as the flanges of the bobbin do not come in contact with the surface along which the shuttle has to pass. To regulate the pressure of the sliding piece on the pivot of the bobbin, it has been proposed to insert a sunk screw at the back of the shuttle to compress the spring as much as necessary. This arrangement, however, shortens the length of the bobbin. The pivots and sockets are very liable to wear unevenly, causing the bobbin to wriggle, and attempts have therefore been made to introduce in their place axles working in circular bearings, Fig. 26. The exterior surfaces of the flanges of the spool are in this case also rounded off so as to cause the least amount of friction when brought in contact by the tension of the thread, alternately with one or other of the bearings. The diameter of the axles is from $\frac{1}{16}$ to $\frac{1}{8}$ in. The difficulty is in this case to prevent the bobbin shifting longitudinally, and thus causing irregularity in the tension of the thread. In fact the desideratum in the construction of the shuttle and bobbin is to allow the tension of the

thread to be varied at will without being liable to accidental alterations. A greater power being necessary to overcome the friction of the spool, as the thread runs off, owing to the diminished leverage, it follows that the tension of the thread itself must vary according as the spool is more or less full. This variation does not allow of the axis of the bobbin being made thin so as to take as much thread as possible on the spool, and it is therefore generally made $\frac{1}{12}$ to $\frac{1}{16}$ in. diameter. Springs pressing either on the flanges of the bobbin, or the thread itself have been tried, but these are only applicable to bobbins running in bearings, the disadvantages of which arrangement have been before shown, and the construction in Fig. 29 has therefore been generally adopted. The friction of the bobbin is, however, not sufficient for the tension of the thread, and the exterior of the shuttle is therefore provided with a row of eyes, *i h*, through which the thread is passed. Their diameter is generally $\frac{1}{24}$ in., so as to allow the thickest thread to pass freely through them, and they must be perfectly smooth and without sharp edges. The thread is conducted through these holes, either alternately from the in to the outside, or passes through each eye from the exterior, being carried thither through the slit, *h*, parallel with the eyes. This increases the tension of the thread and enables it to be regulated by passing the thread through a greater or less number of eyes. The thread is not conveyed direct from the bobbin to the eyes, as this would again increase the variation in its tension, but passes through a slit, *f*, in the lower surface of the shuttle over the upper edge, *g*, into the eyes. The upper part of the shuttle is rounded off where the thread passes over to

prevent the thread coming in contact with the shuttle race and becoming frayed. This is the simplest manner of stretching the thread as required; other methods have been tried, but the above described has always again been reverted to.

The original shuttle presented a rectangular section, and the spool lay loose in it, so that the thread frequently became entangled and sudden alterations in the tension occurred.

SHUTTLES FOR HORIZONTAL CURVILINEAR MOTION.

The shuttle in this arrangement runs with one side against a cylindrical surface in which is the vertical groove for guiding it. The shuttle can retain the shape previously described, except that its surface running on the cylinder, or at least its point, *m n*, Fig. 26, must be rounded off. A new description of shuttle of a cylindrical form, Fig. 30, has, however, come into general use. It is constructed as thin as possible, $\frac{1}{32}$ to $\frac{1}{24}$ in., with a solid point, and cut off at its heel at an obtuse angle. The point is also rounded off on the side next the guide plate, forming the surface, *h*, which serves to keep the shuttle, which would otherwise be apt to turn on its axis, in its right position. This shape might also be applied to shuttles having a rectilinear motion, by slightly altering the form of the point. A slit, *k*, is made on the side opposite to the surface, *h*, 1^{'''} in width, parallel to the axis, and running nearly the whole length, of the shuttle. This is intended to guide the steel-plate, *c e*, by which it is entirely filled, and to which two cylindrical plates are attached at right angles, the one, *g*, as a cover to the shuttle, and for the one pivot of

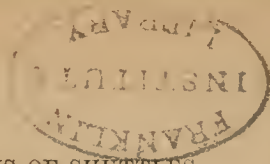

the spool to work in, and the other to support the box, *d*, containing the spring for the moveable socket, *f*. The thread on leaving the spool passes through the curved opening, *i k*, and then through a series of eyes in the plate, *l m*, which is brazed on parallel to the axis on the top surface of the shuttle, so that the one side of it runs along the guide plate of the shuttle, and assists in keeping the latter in its correct position. To insert the spool in the shuttle it is first placed in the holder, the end of the thread passed through *i k* from the interior, and the holder is then slipped into the shuttle. The chief advantage of this description of shuttle is that the needle need not descend so low, as there is no edge round which the thread can twist. The needle has also not again to descend, after completing the loop, to allow of the passage of the shuttle through the loop, but only to stand still, or may even slowly continue its ascent; but must, at the moment of the shuttle quitting the loop, still be some distance from its extreme point of ascent.

SHUTTLES WITH VERTICAL CURVILINEAR MOTION.

For this motion the shuttle itself must be curved correspondingly to the arc of the circle described by it, Fig. 27. It is evident that this description of shuttle cannot contain so large a spool as the straight shuttle above described, and attempts have therefore been made also to employ the latter for vertical curvilinear motion, but without success, as the eye of the needle must then always remain below the lower edge of the shuttle; this increases the necessary length of the shaft of the needle, which should always be round. A straight cylindrical

shuttle would answer better, and is occasionally employed. To enable the curved shuttle to accommodate a larger quantity of thread the spool has also been entirely discarded, and the thread is laid in a kind of ball or cop loose in the shuttle, which is then enclosed on all sides. It is necessary in this case for the thread to be very carefully wound by means of a peculiar contrivance. The thread runs from the interior of the ball, but is so apt to get entangled that this arrangement has come but little into use. The shuttle runs in grooves varying in shape according to the direction of its motion, and is put in operation by a so-called shuttle driver. It is evident that the entire length of the shuttle having to pass through the loop, it cannot be connected with the driver, which must therefore only act on such parts of the shuttle as are for a time free from the loop, viz.: at the commencement of the advancing and the end of the returning motion on the heel, and at the commencement of the returning and the end of the advancing motion on the point of the shuttle. In the original arrangement, therefore, two drivers were made use of, which were, however, soon combined by drilling a hole in each extremity of the shuttle, in which two corresponding catches of the shuttle driver fit, the one relinquishing its hold when the other commences its action. In 1849 Morey introduced the shuttle driver now in use in which these two studs are omitted, consequently dispensing with the corresponding holes in the shuttle, and which consists of a lever with a projection at either end, by which the shuttle is alternately driven backwards and forwards. The shape of these projections has undergone many

alterations, instances of which will be adduced. The driver has been still more simplified by applying it to the heel only of the shuttle, in place of at its front and back extremities; to the heel of the shuttle a projecting lip is attached forming a socket for the reception of the nose of the hammer-shaped reciprocating driver.

This arrangement cannot, however, be recommended, as it allows the point of the shuttle too much play in an upward direction. As unimportant variations, may be mentioned the construction of the driver for various sized shuttles, the imparting to it a slight return motion to allow of the loop slipping freely from the shuttle, as also by the application of a crank motion to propel the shuttle faster in its advance than its return, so as to shorten the dwell of the needle in its deepest position. To avoid the friction of the thread on the exterior surface of the shuttle, and the necessity of the needle standing still, by which the application of a crank motion is precluded, a moveable hook attached to the driver has been introduced, which catches the loop, and holding it open allows of the passage of the shuttle without the thread of the latter coming in contact with the loop. This may be considered as the transition to

SHUTTLES WITH FIXED SPOOLS.

The spool on which the thread, by which the loops of the upper thread are fastened, is wound, has in this arrangement only a revolving motion. A hook catches the loop and draws it over the spool. This hook, or looper, has either a reciprocating or rotating motion. The former is, however, but seldom employed owing to the complicated arrangements necessary, and develop-

ments of the rotating looper appear to be the direction in which we must look for further improvements in the construction of sewing-machines.

The spool, Fig. 10, A B C, Plate VII, is so constructed that the thread of the loop slips easily and without friction over it, and owing to its answering the purpose of a shuttle it is not unfrequently so called. It consists of two halves brazed together formed of steel plate $\frac{1}{4}$ to $\frac{1}{3}$ " thick, well turned and polished, and the thread passes through the slit formed by the edges of the two halves. The slit is usually $\frac{1}{8}$ " in., as this description of machine is mostly employed for fine work, and the edges must of course be rounded off so as to avoid fraying the thread. There are two requisites in the construction of the spool, viz. to allow as much interior space as possible, and to avoid too great a difference in the circumference of the thread when the spool is full and nearly empty. The spool is therefore generally made broader towards its axis, having generally 2" as its greatest breadth, and the axis itself varies from $\frac{1}{3}$ to $\frac{1}{2}$ of the diameter of the spool, which is between 14 to 15". To still further diminish the friction of the loop passing over the spool, the axis is sometimes sunk as in C, Fig. 10, Plate VII. The spool is contained in a hollow on the front side of the looper, so that the surface of the former exposed to view, *q*, Fig. 7, appears as a continuation of the front surface of the looper. The shape of this hollow, *r s*, is shown in the drawing. Between the hinder surface of the spool and that of the hollow is a space of $\frac{1}{2}$ in.

The needle having ascended $\frac{1}{2}$ in., the point of the looper rotating in the direction of the hands of a watch,

reaches the needle $\frac{1}{8}$ to $\frac{3}{16}$ in. above its eye, Fig. 22, A, and the needle continuing its ascent, the point penetrates still further the loop, Fig. 22, B, till the latter can slip no further on the projecting point, Fig. 22, C, and therefore falls into the groove, *ef*, Fig. 7, which runs round the periphery of the cylindrical surface of the looper, becoming narrower and shallower till it terminates in the vertical surface *g*. The farther the looper advances the longer the thread of the loop is extended in the groove, while the one side of the loop is compelled to slip behind the spool, and the advance being continued, Fig. 22, D, the thread conveyed by the groove reaches the above-mentioned vertical surface, and slips from it over the front surface of the spool. The loop has now reached a perpendicular position, Fig. 22, E, twisted diametrically round the spool, and would, the motion of the looper being continued, slip still farther to the left, passing over the spool, and at once quitting the looper, were it not for the so-called break acting against the circumference of the looper, Fig. 22, A, by which the loop is retained till the point of the looper has entered the fresh loop, Fig. 22, B, and there is no longer any fear of the old loop being again caught. The loop is freed from the break on the vertical surface of the looper reaching the latter, and leaving sufficient space for the thread to pass. The second point of the looper is only of secondary importance. A portion of the thread of the loop slips over its front surface, Fig. 22, E, when the loop commences to leave its perpendicular position and approaches the break, which being reached, the hinder thread of the loop slips off this second point, which is calculated to reach the needle at its deepest

point of descent. It is therefore evident that the looper must have travelled the distance of the two points from one another, while the needle has ascended $\frac{1}{16}$ to $\frac{1}{12}$ in. Their distance from one another will therefore be $\frac{3}{8}$ in., if we reckon them to be $\frac{1}{16}$ in. from the centre of the looper. If the diameter of the looper is $\frac{3}{4}$ in., it follows that the points are $\frac{1}{16}$ to $\frac{1}{12}$ in. distant from the extreme periphery of the looper. The hinder surface of the second point is also flat, but lies a little more forward than that of the first, so as to allow of sufficient space between it and the needle ($\frac{1}{2}$ "'). This arrangement was first introduced by the Americans, Wheeler and Wilson, though not exactly as has been described, having undergone many modifications and improvements.

In some machines the spool has a reciprocating motion given to it in the direction of the axis of the looper, which is in this case hollow to allow of the passage of the spool.

II. THE MECHANICAL ARRANGEMENTS OF THE SEWING-MACHINE.

It has been shewn that all sewing-machines have a needle operating from above, and a contrivance below operating with it, the motion of each being dependent on that of the other. The mechanism by which the necessary motion is imparted to the needle is separated from that of the lower portion of the apparatus by the so-called *sewing plate*, containing the *needle hole*, through which the needle passes in its ascent and descent. The material to be sewn rests on the sewing plate, and is advanced the length of a stitch after the completion of each stitch by

means of the feed motion. There is also an arrangement for regulating the tension of the thread. Affixed to the sewing plate, at a distance varying from 3 to 12 in. from the needle hole, is a bent arm, or overhanging bracket, the head of which terminates above the needle hole and serves to support part of the mechanism. The height of the head from the needle hole varies from 1 to 5 in., but is generally above 3 in. A line drawn from the needle hole to the base of the arm is called the *axis of the machine*. Looking from the needle hole towards the base of the bracket are the right and left sides of the machine. The bracket is affixed to the hinder part of the machine, the needle hole is situated in the front.

THE MECHANISM FOR COMMUNICATING MOTION TO THE
NEEDLE.

The needle has an ascending and descending motion perpendicular to the sewing plate, and is affixed to the lower end of a shaft working in perpendicular guides, and called the *needle carrier*. To compensate for the wear by friction of the guide plates, the needle carrier shown in Plate VI., Figs. 1 and 2, $\pi\kappa\rho$, allows of the plates being adjusted to it by means of a screw, the friction being also much lessened. The shape shown, Plate V., Fig. 10, is almost equally good, but is surpassed by that of Fig. 9, Plate IV. The one prism-shaped guide of the carrier is a fixture, while the other, admitting of a slight horizontal movement, can be tightened up by a screw when either the carrier or the guide has become

worn. Both right-angled and cylindrical carriers are very liable to work loose.

The needle is attached to the carrier by a screw in various manners. In Plate IV., Figs. 1 and 2, it is shown fastened in a groove running parallel to the axis of the carrier by the head of a square bolt passing through the carrier, and tightened by a screw and nut. In Fig. 1, Plate VI., it is fastened by a wedge, *p*, to which a screw is attached. In larger carriers the needle is fastened in a perpendicular bore provided with a set screw, *o*, Plate V., Fig. 1. In round carriers, or such as have their lower extremity round, a nut, *B*, Plate II., Fig. 12, with a conical bore, compresses the cone-shaped slotted end of the carrier on the needle.

It is absolutely necessary that the needle should be perfectly parallel to the axis of the carrier, and should this not be the case when fitted, it must be bent in the right direction, and the shanks of the needles are therefore generally left untempered.

The needle carrier must be constructed as light as possible, consistent with the necessary solidity, but owing to the friction even then attendant on its use, the needle has been attached to the end of a lever, 6 to 8 in. in length, moving in a perpendicular plane. This is in fact the first arrangement, the needle carrier having been first introduced in 1846. It is chiefly employed for light work on account of the weakness of the needles, owing to the curved form which must be given them corresponding to the arc described by them. As this curve must exactly correspond to that described by the end of the lever, this description of needle is generally pro-

vided with a flat shank to prevent the needle from turning.

Motion is communicated to the needle by means of a shaft, with either a crank worked by hand, or a fly-wheel connected by driving bands with a treadle. This shaft is called the main or driving shaft, and is always horizontal. Its position varies, being in some machines above, in others below the sewing plate; it is also placed sometimes parallel, sometimes perpendicular, to the axis of the machine. The means of transmission of motion from the main shaft to the needle also vary, a crank being generally sufficient, otherwise an eccentric slot is employed.

There are therefore eight various combinations which will be described below.

The main shaft lies above the sewing plate, parallel with the axis of the machine, and motion is transmitted by means of a crank. Instead of an ordinary crank a round plate, or disc, is generally affixed to the front end of the main shaft, having a projecting stud passing through one end of a connecting rod, the other end of which is attached to the needle carrier. As it is generally advantageous to cause the needle to dwell at its highest and lowest points of motion, the connecting rod is usually made short in proportion to the length of the crank—it is frequently not more than $\frac{1}{4}$ in. longer than the latter.

The main shaft lies above the sewing plate, parallel to the axis of the machine, and motion is transmitted by means of an eccentric slot. This arrangement is similar to the one just described, except that the disc is provided on its front surface with an eccentric slot in which a

friction roller, attached by a pin to the needle carrier, works. (See machine shown in Plate I.) In this instance the slot revolves while the pin has the ascending and descending motion. In Plate IV. a machine is shown in which the roller is attached to a pin in the disc, while the needle carrier itself is slotted.

The main shaft lies above the sewing plate perpendicular to the axis of the machine and motion is transmitted by a crank. It is evident that in this arrangement the main shaft must be placed in the rear of the bracket, as its transmission gearing would otherwise diminish the space for the passage of the material to be sewn. This position of the main shaft also requires the circular motion of the crank changed, by a connecting rod, into a rectilinear one to be transmitted to the needle carrier by a lever. If the guide of the connecting rod is perpendicular the lever must be straight, if diagonal or horizontal, a bent lever must be employed. In the first case, Plate VII., Fig. 24, the shaft would be placed but a slight distance above the sewing plate; in fact, it would be most advantageous in machines having the main shaft perpendicular to their axis to place it below the sewing plate. In the second case the back of the machine would have to be disproportionately lengthened, and this arrangement is therefore but seldom employed.

The main shaft lies above the sewing plate perpendicular to the axis of the machine, and motion is transmitted by an eccentric slot. This slot is constructed in the plate attached to the front end of the main shaft, and the transmission roller forms the end of a lever communicating motion to the needle carrier. The arrangements

vary slightly, according as a straight or bent lever is employed, but the principle remains the same.

The main shaft lies below the sewing plate, parallel to the axis of the machine, and motion is transmitted by a crank. The crank is affixed to the back end of the shaft, and gives motion by means of a universal joint to a connecting rod moving in a perpendicular plane, to the other end of which the end of a horizontal lever is attached by which the motion is transmitted to the needle carrier. See Fig. 29, also machine shown in Plate II.

The main shaft lies below the sewing plate, parallel to the axis of the machine, motion being transmitted by means of an eccentric groove. (See machine shown in Plate V.) The groove is in this instance on the exterior of a cylinder attached to the main shaft, and the roller transmitting the motion to a bent lever has a reciprocating motion, almost rectilinear, horizontal to the surface of the cylinder, Plate VII., Fig. 30. The path of the roller is a flat curve, the plane of which is perpendicular, parallel to the axis of the shaft, and touching the cylinder in a straight line from which the curve described deviates but slightly. To reduce this deviation as much as possible, the lever arm to which the roller is attached, as also the diameter of the cylinder, are made as large as possible, and the curve described by the roller is so arranged that its extremities are just the same height above the point of contact as its centre is below.

The main shaft lies below the sewing plate, perpendicular to the axis of the machine, and motion is transmitted by a

crank. The principle of this construction, Figs. 31 and 32, does not differ from that shown in Figs. 24 and 25. The proportions of the parts alone vary.

The main shaft lies below the sewing plate, perpendicular to the machine axis, and motion is transmitted by an eccentric groove. This arrangement, Figs. 33 and 34, also corresponds with that shown in Figs. 27 and 28, except that the straight lever shown in Fig. 27 is replaced in Fig. 33 by a lever bent at an obtuse angle, and that the proportions of the various parts differ. Assuming the main shaft in the front part of the machine, the lever takes the form of \supset . By giving the roller the rotating, the groove the reciprocating, motion, and making the groove retilinear, we obtain the form of arrangement shown in Plate III.

In most of these arrangements motion is transferred to the needle carrier by a lever which is attached in various manners. Either the end of the lever has a slot, in which a stud attached to the needle carrier travels, or a short connecting rod is employed. This arrangement with levers alone makes it possible to dispense with the needle carrier, and to employ curved needles. As, however, when curved needles are made use of, the fulcrum of the lever must be but slightly above the sewing plate, a straight lever is inadmissible. In Plate VII. a machine of this description is shown according to the plan of Fig. 31.

THE TRANSMISSION OF MOTION TO THE LOWER MECHANISM.

The arrangements below the sewing plate vary much in different machines. They may be thus classified: Those with a rotating motion, including the revolving

hook of the single-thread chain-stitch machine, and the revolving looper of the quilting-stitch machine, and those with a reciprocating or oscillating motion. These latter may be again divided into those with curvilinear and those with rectilinear motion. Those with a curvilinear motion describe either an arc with a very small angle, as the looper of the single-thread chain-stitch machine, and the similarly constructed double-thread chain-stitch machine, or an arc with a larger angle, as in machines with travelling shuttles; or, lastly, almost a perfect circle, as the looper of the double-thread chain-stitch machine of Grover and Baker.

I. THE REVOLVING HOOK

is always attached to the end of the main shaft, which must therefore in this arrangement be below the sewing plate, and the mechanism for communicating motion to the needle must be arranged accordingly. (See machines shown, Plates II. and VII.)

II. THE HOOK WITH RECIPROCATING MOTION.

This hook makes, as previously described, a short motion from left to right, and then a still shorter lateral one; a pause occurs, and it then retraverses the same path. The motion from left to right and right to left is called the main motion, the other the side motion. The latter is effected in the following manner: The looper is affixed to a double-jointed lever swinging in a horizontal plane by means of a hinge, the axis of which is perpendicular. Lines drawn from the centre of the hinge to the point of the looper, and to the fulcrum of the lever, form an obtuse angle with its opening to the right. A spring, *k*, attached to the lever and

pressing against a projection, *h*, of the looper (Plate I., Figs. 21 and 22), the so-called heel, endeavours to diminish this angle, but can only effect this in a limited degree on account of the pin *i*. The looper having concluded its motion from left to right, a part of it impinges on the pin *m*, and the lever continuing its motion, the point of the looper must move forward in the direction of the arrow. The side motion need therefore not be brought into consideration. The crank motion is inapplicable in this arrangement, and an eccentric groove must impart the necessary motion. The main motion must always be in the same direction as the movement of the material to be sewn, perpendicular to the axis of the machine. We have therefore only four arrangements to consider, according as the main shaft is above or below the sewing plate, parallel or perpendicular to the axis of the machine. By taking into consideration that the plane of oscillation of the looper might be perpendicular the number of arrangements might be increased to eight, but only the four following will be described:

The main shaft lies above the sewing plate, and parallel to the axis of the machine. The plane of oscillation of the looper is horizontal. At the rear end of the shaft is a disc with an eccentric slot, in which a roller rotates, attached to the end of a lever vibrating in a plane perpendicular to the axis of the machine. Plate VII., Fig. 35. The hinder end of the lower lever presses against the end of the lever vibrating horizontally. The roller therefore only comes in contact with the interior side of the eccentric groove, and a plate of an eccentric form is therefore frequently substituted. (See arrangement of machine in Plate I.)

The main shaft lies above the sewing plate, and perpendicular to the axis of the machine. The plane of oscillation of the looper is horizontal. A cylinder is attached to the shaft in which is the groove. The hinder end of the lower lever is turned upwards, and supports on a vertical pin the roller running in the groove perpendicularly below the main shaft. (Plate VII., Fig. 36.)

The main shaft lies below the sewing plate perpendicular to the axis of the machine. The plane of oscillation of the looper is horizontal. This arrangement differs but little from the preceding ones, except that the end of the lever need not be turned up.

The main shaft lies below the sewing-plate, parallel with the axis of the machine. The plane of oscillation of the looper is perpendicular. The disc with the eccentric slot is attached to the end of the shaft and the roller between the looper and the pivot of the lever, Fig. 37. If, however, it is intended to give the vibrating motion to the groove, the roller is attached to a crank plate on the main shaft, Fig. 38.

3. SHUTTLES WITH CURVILINEAR OSCILLATING MOTION.

The shuttle is situated at the end of a lever describing in its motion an angle of generally 45 to 60 deg., but seldom exceeding 90 deg. The lever vibrates either in a vertical or horizontal plane, and the chord of the arc described can be parallel or perpendicular to the axis of the machine, of course always in a horizontal plane. As the main shaft can also be parallel or perpendicular to the axis of the machine, the position of the chord of the arc to the main shaft must be either parallel or perpendicular. Taking into account that the shaft can

either be above or below the sewing-plate, and that the motion can be imparted either by a crank or eccentric groove, sixteen different variations can occur, the principal of which are described below.

The plane of oscillation is horizontal, the main shaft lies below the sewing-plate, parallel to the chord of the arc of oscillation, and motion is transmitted by means of an eccentric groove. The groove is situated either on the plane surface of a disc on the main shaft, Plate VII., Fig. 39., or on the circumference of a cylinder attached to the shaft, Fig. 40. In both cases a two-armed lever transmits the motion by means of a connecting rod to another two-armed lever which is straight when the groove is in a disc, and bent when the groove is in a cylinder.

The plane of oscillation is horizontal, the main shaft lies above the sewing-plate perpendicular to the chord of the arc of oscillation, and motion is transmitted by an eccentric groove. A two-armed straight lever transmits the motion from the eccentric groove, by means of a connecting-rod, to a second lever actuating the shuttle. This latter lever is single when the groove is in a disc and the main shaft is perpendicular to the axis of the machine, Fig. 41. It is two-armed and bent when the groove is in a cylinder, and the shaft runs parallel to the axis of the machine, Fig. 43. If the groove is in a cylinder and the shaft perpendicular to the axis of the machine, the lever assumes dimensions presenting considerable difficulty.

The plane of oscillation is horizontal, the main shaft below the sewing plate, parallel to the chord of the arc of oscillation, and motion is transmitted by a crank. The shuttle is situated on the long arm of a bent lever, the short

arm of which is joined to the crank by a connecting-rod. As the crank is very short a simple crank-pin would be sufficient, lever and connecting-rod being joined by a universal joint, Fig. 44.

The plane of oscillation is horizontal, the main shaft below the sewing-plate parallel to the chord of the arc of oscillation and motion is transmitted by an eccentric groove. This combination allows of the very simple arrangement shown in Figs. 45 and 46, the latter of which is particularly applicable when the shaft is parallel to the axis of the machine.

The plane of oscillation is horizontal, the main shaft below the sewing-plate perpendicular to the chord of the arc of oscillation and motion is transmitted by a crank. The shuttle is placed at the end of a straight two-armed lever, the short arm of which is attached to the crank by means of a connecting-rod, both ends of which are fitted with universal joints, except when it is very long, when a simple cylindrical crank-pin will be sufficient, Fig. 47.

The plane of oscillation is horizontal, the main shaft below the sewing-plate perpendicular to the chord of the arc of oscillation and motion is transmitted by an eccentric groove. The shuttle is situated at the end of the longest arm of a bent lever to the other arm of which the roller is attached, running in the groove of a cylinder, Fig. 48. See also arrangement of machine, Plate V., Figs. 20 and 21.

The plane of oscillation is perpendicular, the main shaft above the sewing-plate parallel to the chord of the arc of oscillation and motion is transmitted by a crank. The lever carrying the shuttle is attached to a horizontal shaft

running parallel to the axis of the machine, and to the hinder end of which a short lever having a horizontal motion is attached receiving motion from the crank by means of a connecting-rod with a universal joint. This arrangement, Fig. 49, is, however, only practicable when the shaft is perpendicular to the axis of the machine.

The plane of oscillation is perpendicular, the main shaft above the sewing-plate parallel with the chord of the arc of oscillation and motion is transmitted by an eccentric groove. To the main shaft a cylinder is attached with a groove giving motion by means of a roller to a lever with perpendicular motion. Parallel to the axis of this lever is a shaft below the sewing-plate, to the front of which is attached the lever with the shuttle, the other end being connected with a small lever bent upwards, and connected with the end of the lever carrying the roller, Fig. 50. This arrangement can only be employed when the main shaft is perpendicular to the axis of the machine. Otherwise the lower end of the lever carrying the roller is joined to the shuttle-lever by a connecting-rod, Fig. 51.

The plane of oscillation is perpendicular, the main shaft above the sewing-plate perpendicular to the chord of the arc of oscillation and motion is transmitted by a crank. This combination can only be effected when the shaft is parallel to the axis of the machine. The crank-pin is attached to a horizontal lever by means of a connecting-rod attached to the hinder end of a shaft having the shuttle-lever at the other end, Fig. 52.

The plane of oscillation is perpendicular, the main shaft above the sewing-plate perpendicular to the chord of the arc of oscillation and motion is transmitted by an eccentric groove. The construction, necessary in this case, is similar to that

shown in Figs. 50 and 51, substituting for the cylinder a plate with eccentric groove, Figs. 53 and 54.

The plane of oscillation is perpendicular, the main shaft below the sewing-plate, parallel with the chord of the arc of oscillation and motion is transmitted by a crank. The construction necessary in this case is similar to that shown in Fig. 49, except that the shaft is below the sewing-plate. This arrangement cannot, however, be recommended, as the connecting-rod must be so much shortened that the friction of the joints becomes disproportionately increased.

The plane of oscillation is perpendicular, the main shaft below the sewing-plate, parallel with the chord of the arc of oscillation and motion is transmitted by an eccentric groove. If the main shaft is perpendicular to the axis of the machine, a cylinder with the eccentric groove is attached to it, by which a short perpendicular lever is put in motion, communicating with the hinder end of a shaft to the front end of which the shuttle is affixed, Fig. 55. The lower lever-shaft can be also so shortened that both levers fall together, and the roller is attached to the shuttle-lever direct. If the shaft is parallel to the axis of the machine the cylinder with the groove in it puts a short lever moving in a perpendicular plane in motion. This is again connected by a rod having a horizontal motion with a corresponding point of the shuttle-lever by a hinge, Fig. 56. Dispensing with the connecting-rod the two levers become united, and the roller is attached direct to the shuttle-lever.

The plane of oscillation is perpendicular, the main shaft beneath the sewing-plate, perpendicular to the chord of the arc of oscillation and motion is transmitted by an eccentric

groove. This construction is similar to the foregoing, substituting for the cylinder a disc in which is the groove, Figs. 57 and 58. In this case the oscillating motion is frequently given to the groove, the rotating motion to the roller, especially when the groove is rectilinear.

The plane of oscillation is perpendicular, the main shaft below the sewing-plate, perpendicular to the chord of the arc of oscillation, and motion is transmitted by a crank. The crank pin is connected by a rod having a horizontal motion to a suitable point of the shuttle lever.

4. SHUTTLES WITH RECTILINEAR MOTION.

The shuttle is propelled, as before described, by the driver, which is attached, in the case of shuttles with curvilinear motion, to the end of a lever arm. With shuttles, however, having rectilinear motion, the driver generally consists of two parts, the one for imparting motion to the shuttle, the other, the so-called slide, serving as a guide. They are attached by means of screws. The section of the slide like that of the needle-carrier, to which it may be compared, varies considerably. The shapes most in use are shown, Plate IV., Figs. 1 and 18; Plate V., Figs. 1, 14 and 15; Plate VI., Fig. 9. The horizontal race in which the shuttle runs is either parallel or perpendicular to the axis of the machine; and as the main shaft can also be parallel or perpendicular to the axis of the machine, it must also be either parallel or perpendicular to the shuttle-race. The shaft can also be either above or below the sewing-plate, and motion can be transmitted either by a crank or eccentric groove, making in all eight varieties of construction, details of

which are, however, unnecessary, as those previously given may be readily modified to suit the rectilinear motion, it being only necessary to connect the lever, to which, in shuttles with curvilinear motion, the shuttle was attached, by means of a rod to the shuttle-driver slide. In many cases the lever may be entirely dispensed with by attaching the connecting-rod to the shuttle-driver slide by means of a hinge, especially when motion is transmitted by a crank, as shown (Plate IV., Fig. 1; Plate V., Fig. 1). If the eccentric groove is used the roller is attached to a prolongation of the slide, which much simplifies the arrangements (see plate VI., Fig. 4).

5. LOOPER WITH LONG RECIPROCATING MOTION.

The double thread chain-stitch looper of Grover and Baker reciprocates on a perpendicular axis, and describes almost a perfect circle. The following is the arrangement now generally employed for communicating motion to the looper: To the axis of the looper a small cylinder is attached, round which an eccentric groove runs and a roller attached to the end of the \sqsupset shaped needle-lever imparts a reciprocating motion to the cylinder. Latterly this arrangement has been somewhat modified by employing a nut instead of the roller, and giving the groove a screw form.

THE MECHANISM FOR IMPARTING MOTION TO THE MATERIAL.

The material to be sewn is advanced at the completion of each stitch the length of a stitch. The sewing plate itself is constructed generally of cast-iron, less frequently of brass or steel; but the sewing hole is almost

invariably constructed in a piece of steel screwed into the plate, as the friction of the thread would otherwise be apt to enlarge the hole. This sewing-hole plate is made as thin as practicable; as the thinner this is the less distance need the lower mechanism be from it, and the shorter the needle. It is never more than $\frac{1}{16}$ in. thick, frequently only $\frac{1}{32}$ in. The hole must only be sufficiently large to admit of the free passage of the thickest needle with the thickest thread that is to be employed, as, if it is too large, the material is apt to be drawn down into it during the descent of the needle, and if too small, the thread is liable to fray and break. Machines for sewing thin materials, as shirt-fronts, &c., have a sewing-hole of $\frac{1}{2}$ " diameter, and the size increases according to the thread employed up to $\frac{1}{8}$ in. for sewing sail-cloth. The most usual sizes are between $\frac{1}{16}$ in. and $\frac{1}{12}$ in. The sewing hole must be well rounded off, and is generally enlarged downwards so as to give play to the thread and cause as little friction as possible.

The material is held down by the so-called *presser* during the formation of the stitch, and at the completion of the stitch, is advanced by the feeder the length of a stitch. This feeder is roughened on its surface, and is situated beneath the presser and rising out of the sewing-hole plate, advances, carrying the material with it. Sometimes the feeder is dispensed with, and in this case the surface of the presser foot is roughened, and it is so constructed as to make the necessary advance. The mechanism has therefore to be arranged for

I.—FEEDERS WORKING FROM BELOW.

The presser, in this case, consists of an iron rod, to the lower end of which a steel piece is screwed, called

the foot. As the pressure requires to be applied as near the needle-hole as possible, it would appear most advantageous to place the presser immediately above the hole, leaving in it an aperture sufficiently large for the passage of the needle and thread. This, however, prevents the requisite direction being given with exactitude in other than straight seams, and a slit is therefore made in the foot rather wider than the diameter of the sewing-hole, or a piece of glass having a hole in it is inserted in the foot. A guide-plate is however now generally attached by screws to the sewing-plate, and the foot of the presser is so constructed that its side only slightly projects over the sewing-hole, and a semi-circular groove in this side allows of the passage of the needle. The presser foot is always situated on the front side of the sewing-hole, as otherwise the material would have to pass through the aperture between the bracket-arm and the sewing-plate. The presser rod is placed either to the right or left of the needle-carrier. In machines whose axis lies crossways, the rod is placed to the left so as not to impede the view of the person working. See machines shown, Plates II., III., IV., and V.

The rod itself may be either round, square, or rectangular. In the first two cases the lower end of the rod is made square and fitted with a screw or matrix, and the foot fitting on the square is attached by a screw to the rod. See *p*, Fig. 2, Plate V. ; *S*, Fig. 2, Plate II. If the rod is rectangular the foot is generally spliced on and attached either by rivets or a screw, see Plate IV., Fig. 2. A round rod works in two sockets, and is prevented from turning by a small stud working in a vertical slot, Plate VII., Fig. 16 ; Plate II., Fig. 2. The pressure is applied by means of a spiral steel spring

encircling the rod and pressing against the before-mentioned stud, Plate III., Fig. 2. This arrangement is also made use of with square rods, the spring in this case pressing direct on the foot, Plate V., Fig. 2, and the rod working in sockets; reetangular rods, on the contrary, generally work on one of the perpendicular sides of the braeket-arm, Plate IV., Fig. 2.

To plaee the material to be sewn in its right position the presser must be raised, which is effected by an eccentric attached to a lever. This eccentric is either attached to the presser itself, or to the arm of the machine. Various modes of application are shown, Plate II., Fig. 12, A a, Plate III., Figs. 1 and 2; Plate IV., Fig. 2; Plate V., Fig. 2, and Plate VII., Figs. 1 and 2. The presser is raised from $\frac{3}{16}$ to $\frac{5}{16}$ in. according to the thickness of the material to be sewn. The distance is always made as small as practicable, as the length of the needle increases in proportion so as to prevent the needle earrier coming in eontaet with the foot. The feeder itself consists of a flat reetangular roughened steel plate which, rising from an opening in the sewing-hole plate, advances the material the length of a stitch, then sinks and returns to its former position. A feed-wheel, the circumference of which is roughened, is somctimes employed, to which an intermittent circular motion is given. The feed-plate has a breadth of from $\frac{1}{16}$ to $\frac{1}{4}$ in. according to the material to be sewn, and is generally $\frac{1}{2}$ in. in length. Sometimes the part behind the sewing-hole is made narrow, Plate VII., Fig. 12. The flutes of the surface of the feed-plate have the sectional form of a right-angled triangle having its hypothenus in the direction of the motion of the

material, and vary in fineness, some being $\frac{1}{16}$ in. from each other, and $\frac{2}{3}$ of this in depth, others being so fine that 3 or 4 are contained in a line. The opening in the sewing-hole plate is of exactly the same breadth as that of the surface of the feed-plate, and of a length equal to that of the latter and the length of the stitch to be made. The roughened plate is attached to a larger piece to which motion is applied by the co-called feed eccentric which is affixed to the main shaft, and consists generally of two separate eccentrics, the one communicating the ascending and descending, and the other the to and fro motion. It will be perceived that in this arrangement the main shaft must be below the sewing plate. In Fig. 2, Plate II., the feeder, CC., slides on the pin bolt round which it has also a slight circular motion. The same principle is employed in the arrangement shown in Plate V., Fig. 2, but in this case the sides of V, a section of which is shown in Fig. 7, serve as a guide to the feeder. In Fig. 21, Plate VII., the feed-plate is attached to the end of a lever turning horizontally on, *a b*, running in regular guides.

The horizontal motion is given to the feeder by attaching a horizontal plate against which the eccentric presses. The return motion is effected by a spring.

The shape of the eccentric varies according as the direction of the feed is parallel or perpendicular to the main shaft. In the first case the face and the circumference of the eccentric give respectively the up and down and to and fro motions, in the latter two separate eccentrics are employed for each motion. The advance of the material must take place when the needle is at its highest point, so that it neither bends the needle nor is

retained by it. Another reason for causing the advance to take place at the moment of the needle commencing its descent, is that the thread has then already attained its maximum amount of tension which would have previously been too much increased by a forward motion of the material and would have caused the latter to be drawn together. The rise of the feeder takes place just previous, and the fall just subsequent to the advance of the material. The advance of the feeder in the case of shuttle machines takes place when the shuttle has half penetrated the loop.

The rise and fall of the feeder is generally $\frac{1}{12}$ in., half above, half below the surface of the sewing plate.

Attempts have been made to communicate to the feeder simultaneous rise and advance, as also fall and return motion. The roughened foot is attached to a lever, *a b*, Fig. 16, Plate III., consisting of two parts, *a* and *b*, connected by a hinge. The motion of *b* is, however, circumscribed by a pin, *c*, below the fulcrum, striking the lever, *a*, when the angle formed by the two arms approaches 180 deg. A weak spring attached to *b*, and pressing against *a*, retains the lever in this position until its resistance is overcome. The lever, *a*, being raised by an eccentric in the direction of the feed, the roughened plate rises, presses against the lower side of the material and advances with it. On the lever, *a*, commencing its return, the spring connecting *a* and *b*, yields, the angle of the two levers is diminished, and the roughened plate returns below the material without pressing against it. This arrangement is simple, but is not sufficiently accurate, and has therefore not been much adopted.

THE FEED WHEEL.

For the purpose of communicating an intermittent motion the wheel is provided with a flange of about $\frac{1}{2}$ in. in height, and $\frac{1}{8}$ in. thick, to which is affixed a kind of break, one of the simplest forms of which is shown, Fig. 14, Plate IV. The spring, $d c e$, is constructed of a somewhat larger diameter than that of the flange, so that when inserted in it it has an outward pressure. The two ends, d and e , are hinged on to a lever, d, f , having a radial position. The lever end, f , moving in the direction of the arrow, the spring is extended, and pressing on the flange, carries the wheel with it. On the return of the lever end the spring contracts and is carried back without moving the wheel. The pressure of the presser on the material would alone suffice to prevent a return of the wheel; but a spring is also frequently employed, pressing either against the edge or side of the wheel. This latter arrangement is shown in Fig. 14, Plate IV. The side of the wheel on which is the flange is covered with a plate, g , brazed on to the pivot on which the wheel works, so as to prevent the spring from flying out. Another and earlier arrangement is shown in Fig. 15; it consists of a disc, m, n , having a circular motion independently of the wheel, but rotating on the same pivot. This disc has two prolongations almost diametrically opposite to one another, to the one of which k , a to and fro motion, is imparted, while to the other, l , a spiral spring, f , is attached, pressing the moveable pin, d , against the inner surface of the flange. This pin, d , rests against m, n , its rounded end fitting into a hollow in the same. The lever, k , being moved in the

direction of the arrow, the pressure of d against the flange is increased proportionately, as the direction of d is more or less radial, and the ensuing friction causes the wheel to follow the motion of $m n$. The spiral spring connecting d with l initiates the pressure which is increased by the movement of the lever. On the return of the lever end, k , the pressure of d against the flange ceases, and a spring applied, as before described, prevents the return of the wheel. For the sake of certainty, a second pin, c , similar to d , is employed, having a somewhat different action. It contains a notch, p , fitting over the flange and rests with its other end in a hollow in the centre, $m n$. A flat spring g , attached to the prolongation l , and pressing against c , near the flange, causes the latter to catch in the notch, p . The friction thus caused between c , and the wheel is increased by the motion of k , in the direction of the arrow, so that the wheel must follow the motion of $m n$. On the return of k , the pressure between the flange and the inner surface of the notch p , ceases, and the friction is diminished to a degree preventing the return of the wheel. To obviate any lateral motion either of the wheel or disc on the axis, a small spiral spring, not shown in the drawing, is applied, pressing against both.

Figs. 1, 2, and 4, show the usual construction of the break. It consists of a kind of nipper catching the flange of the wheel constructed with two arms, ρ and ξ , connected by a hinge. One of these arms, ρ , runs in a guide attached to the nave of the wheel, so as to allow of a slight horizontal motion. The two arms are almost at right angles to each other, one being nearly horizontal, the other nearly vertical. On the lower end of the vertical arm moving in the direction of the arrow,

77
1

THE FEED MOTION.

the cam of the arm ξ (*a*, Fig. 11) presses against the exterior surface of the flange, as does also the cam, Fig. 4, attached to the other end of the arm ρ (see Fig. 6.) The spring σ Fig. 2, pressing the arms apart initiates the pressure. On the return of the lever end, ξ , the pressure against the flange ceases and the wheel remains stationary.

It will be perceived that all these descriptions of breaks are so arranged that motion is transmitted to the wheel by a lever-end acting on the break. To communicate a reciprocating motion to this lever-end an eccentric plate is attached to the main shaft, the return motion being effected by a spring, *e*, as shown in Fig. 15.

The axis of the feed-wheel is not a fixture but is inserted in a kind of fork, which can be raised or lowered at will, so that the roughened surface may neither project too much nor lie too deep below the surface of the sewing-plate, as in the latter case the material would not be caught, and in the former it would be raised above the needle-hole, causing imperfect stitches owing to the material rising with the needle.

The dimensions of the feed-wheel vary; but it is not advisable to have too great a difference between the diameter of the roughened periphery and that of the projecting flange, as any irregularity in the working of the break would affect the length of the stitch proportionately to the difference between their diameters. As a rule a diameter of 3 to 4 in. is given to the roughened periphery, and $2\frac{1}{2}$ to $3\frac{1}{2}$ to the break flange.

The feed-wheel is not adapted for work with curved seams, and is therefore mostly employed in large machines for heavy work, with straight, or but slightly curved seams.

II.—FEEDERS WORKING FROM ABOVE.

It has been already mentioned that in these arrangements the pressure and feed motion are combined. The motion of the feeder is in a direction perpendicular to the sewing-plate and the axis of the machine. The feeder, resembling in form the presser before described, works on a pivot, the latter being also free to slide perpendicularly corresponding in principle to the feed motion from below, shown Fig. 2, Plate II. The slot in the feeder giving the perpendicular motion is in the upper end of the arm, a stud affixed to the bracket passing through it. To prevent any lateral motion of the presser foot, the arm of the feed motion is made rectangular, and works in a slot made in the head of the bracket (see Fig. 2, Plate II., and Fig. 10, Plate VI.). The presser and presser foot are frequently constructed in one piece, but, more generally, as shown in Fig. 7, Plate VI., are two distinct pieces hinged together so that the lower serrated surface of the foot is at an angle of 15 to 20 deg. to the sewing-plate, by which means a greater regularity of pressure is obtained, especially where the surface of the material is uneven owing to seams or other causes.

Motion is communicated to the feeder from the main shaft by the so-called feed eccentric consisting of two separate eccentric cylindrical cams, by one of which the rise and fall, by the other, the horizontal motion of the feeder is effected. This feed eccentric is attached to the main shaft, and the arrangements vary according as the shaft is above or below the sewing-plate, parallel or perpendicular to the axis of the machine. On ac-

count of its greater simplicity the arrangements with the main shaft above the sewing plate and parallel to the axis of the machine is to be preferred. In this case the feed eccentric (*d*, Fig. 2, Plate I.) is attached to the front end of the main shaft, and consists usually of only one eccentric cylinder effecting the horizontal motion, the other being replaced by a roller working in the revolving disc, *l*, and acting when in its highest position on the single-arm lever, *f*, the forked end of which is connected with the arm of the feeder, *a b*, by a pin. The descending motion of the feeder is effected by a spring shown in Fig. 1. The forked lever, *f*, is sometimes dispensed with, and a flat spring is attached to the head of the bracket-arm, and presses the feeder down, except when it is itself raised by the roller, when it carries the feeder along with it. The horizontal motion is communicated to the feeder by the eccentric by means of the so-called pendulum, *e*, having its fulcrum on the head of the bracket, and a roller at its lower end, working on the eccentric. As before mentioned, the material must commence its advance with the descent of the needle, and cease before the point has reached the material. The feeder is not raised till the lower mechanism has caught the loop of the upper thread; then follows the return horizontal motion, on the completion of which the action of the feeder on the material again commences. The arrangements are not so simple when the main shaft is differently situated. The feeder itself remains as before and the feed eccentric is also attached to the shaft; but owing to the distance of the eccentric from the feeder a lever becomes neces-

sary for transmitting the motion. The arrangement of this lever, shown Fig. 1, Plate VI., remains the same, whether the main shaft is above or below the sewing-plate, provided it is perpendicular to the axis of the machine. One of the two cams constituting the feed eccentric is cylindrical, on which a roller, μ , attached to the end of the two-armed lever, $v z \mu$, revolves. The other end of the lever is connected with the feeder arm, and is held down either by a spiral spring or elastic band, thus causing the pressure of the feeder on the material, as also its descent after being raised by the action of the stud, s , of the eccentric on the lever. The surface of the second cam is provided with a spiral slot, in which a roller, v , works, communicating a to and fro motion to the lever, w , the axis of which is parallel to that of the machine, and consists of a spindle, e , Fig. 15, the front end of which carries a second lever, $b d$, affixed to which is a stud parallel to the axis, pressing against the feeder, and causing its advance. The return motion is effected by a spring, Fig. 10.

The length of the lever arms, w and $z \mu$ (Figs. 1 and 3), varies according as the main shaft is above or below the machine axis.

It is evident that the greater the rise of the feeder the greater the compression of the spring, and the more power therefore requisite. On this account machines having the feed motion above the sewing plate require more power than those with the motion below. On the other hand, owing to the intermittent pressure, curves and angles can be made with much greater facility in the seam.

THE STITCH REGULATOR.

The principle of the various appliances for regulating the length of stitch is the same, the feeder being detained towards the completion of its return motion by a projection attached to some part of the framework of the machine. Either this projection is moveable, or, as shown in Fig. 2, Plate I., a set screw (*k*) in the feeder itself regulates the length of the stitch. When the feed motion is effected by a wheel with serrated periphery, the connecting-rod is so constructed as to be lengthened or shortened as required. The best regulators, and which are most in use, are constructed with scale attached, and consist of an eccentric disc against which the feeder strikes on its return motion. The scale is marked on the periphery of this disc, and as the disc is turned to increase or diminish the length of the stitch, indicates the number of stitches contained in an inch. This arrangement is shown Fig. 16, Plate IV., Fig. 11, Plate V., Fig. 6, Plate VII.

Fig. 4, Plate II., and Fig. 8, Plate VI., show arrangements without a scale, in which the eccentric disc is regulated by a lever handle.

D.—THE TENSION APPARATUS.

The necessary tension is given to the thread either by applying friction direct to the thread itself, or to the spool on which it is wound, or to a roller over which the thread is made to pass in its passage from the spool to the eye of the needle.

TENSION BY FRICTION OF THE THREAD.

An apparatus constructed on this principle is shown Plate IV., Figs. 1 and 5. To a knee, *t*, affixed to the bracket of the machine a horizontal metal cylinder, *s*, is attached, $1\frac{1}{2}$ to 2 in. in length, and $\frac{1}{2}$ to 1 in. in diameter. To this fixed cylinder a thin metal disc, *a*, is screwed, which is capable of being easily turned, and whose diameter is $\frac{3}{8}$ to $\frac{1}{2}$ in. greater than that of the cylinder. The thread passes through an eye in the projecting part of the disc, round the cylinder, through a second eye in the knee to the reel, *w*. These eyes are constructed either of glass or porcelain, to prevent the thread cutting grooves in the metal disc or knee. The number of turns of the thread round the cylinder can be regulated by the disc, *d*, which is kept fixed by the spring, *u*.

In Fig. 5, Plate V., the thread is conducted between two discs, *v* and *n*, either of metal or glass, the upper of which is pressed against the lower by a spiral spring, *y*, regulated by the screw *z*. The disadvantage of this arrangement is, that variations in the thickness of the thread affect the tension, on which account linen thread cannot be well employed, being spun much more unevenly than silk or cotton.

TENSION BY FRICTION ON THE SPOOL.

In this arrangement a kind of drag is applied to the flange of the spool, which is constructed of boxwood, with a tolerably large diameter and proportionately small flanges, one of which is about $\frac{1}{4}$ in. thick, to allow of the pressure of a spring regulated by a screw. The

spring is frequently covered, at the point of contact with the spool, with a small piece of felt or cloth to soften the friction. The same rule applies to the dimensions of the spool as was given in the description of the shuttle spool.

A better arrangement is shown, Fig. 26, Plate I. The spool, *b*, revolves on the axis, *a*, which is screwed to the machine. A spiral spring, *d*, encircling this axis, presses against the spool. The pressure of the spring, and therefore the tension of the thread, is regulated by the set screw, *e*. Discs of cloth or felt, *g* and *h*, above and below the spool serve to soften the motion, and a metal ring, *f*, is introduced for the spring to press against. The same arrangement is shown in Fig. 6, except that the spiral spring is replaced by a flat one, *c*, the pressure of which is regulated by the screw, *d*.

To avoid applying the friction to the wood of the spool, the latter is sometimes affixed to a conical metal axis, to the conical points of which pressure is applied.

A bent spring, *a*, Fig. 5, attached to the framework of the machine, carries the axis of the spool, and the pressure is increased or diminished by the screw, *c*, attached to the bolt, *b*. A modification of this arrangement is shown in Fig. 7, Plate II. The spool is fitted on a hollow cylindrical axis, *e*, revolving round another fixed axis. The ends of the hollow axis are bored out conically, so that the one end fits on the cone, *b*, attached to the fixed axis, while in the other the cone turned on the piece, *g*, is inserted. The piece, *g*, is also hollow, and is prevented from turning on the cylinder by a small screw fitting in the groove, *c*, of the axis. A ring

of gutta-percha, *h*, replacing a spiral spring, presses against *g*, the pressure being regulated by a screw. Similar arrangements are shown, Figs. 16 & 1, Plate VI.

TENSION BY A ROLLER.

The thread is in this case carried over a special, so-called tension roller, and is frequently first stretched before reaching the roller by means of an arrangement shown in Fig. 4, Plate II., consisting of a hollow cylinder with a slot, *d*, in it, and containing two plugs between which the thread passes. The lower one, *a*, is pressed against the upper one, *b*, by a spiral spring, *c*. The tension-roller has a deep slot round its circumference diminishing in depth, so that the thread, however fine it may be, catches on it, causing the roller to rotate. A drag is applied to the roller by means of a flat or spiral spring.

In Plate VII., Figs. 3 and 20, a tension apparatus of this description is represented. The spool, *b*, revolves round a spindle, and the thread after passing the preliminary stretcher, *c*, is passed once round the tension-roller, *d*, and conveyed to the eye of the needle. The roller revolves round a cylinder, *k*, fitted on the square-fixed axis, *g*, but capable of sliding in the direction of the axis. Washers of felt or cloth on either side of the roller serve to soften the motion. Pressure is applied to the moveable axis, *k*, by a spiral spring, *e*, regulated by the screw *f*.

THE THREAD GUIDE.

The tension apparatus being affixed to the bracket-arm of the machine, the thread is conveyed over the

head of the bracket through an eye provided for this purpose to the eye of the needle. Assuming, now, the machine in work and the needle at its highest point, with the thread tightly stretched, the needle commences its descent without altering the tension or position of the thread till it reaches the material; it then carries the thread with it, unwinding the thread equal to double the distance from the surface of the material to the lowest point reached by the eye of the needle. The needle having reached its deepest point, the action of the tension apparatus ceases, and the formation of the loop below the material commences, and on its completion is caught by the lower mechanism and more or less extended or lengthened, more or less firmly held and at last released. In many cases indeed the loop is held till the needle in making the succeeding stitch has reached its lowest position, and again formed a loop which has been caught by the lower mechanism. It is evident, therefore, that more thread is unwound for the formation of each stitch than is necessary for the stitch itself. The consequence of this would be that the loop would remain as formed; as, though fresh thread would be requisite for the formation of this succeeding stitch, the friction of the cloth is mostly found to be greater than that of the tension apparatus. Only in thin open materials is the formation of the succeeding stitch sufficient to take up the slack of the previous one.

We have seen that at certain periods both the needle, as also the lower mechanism, consume thread, and that both at certain periods release a portion of the thread in use. It might occur that the needle required thread just at the moment of the release of the same length of

thread by the lower mechanism, and in this case the guide before described would be sufficient for the formation of a good stitch. This happens, however, only approximately, the needle consuming at certain moments part of the thread released by the looping apparatus, and *vice versâ*; but this joint action is never sufficiently perfect to prevent the formation of small loops on the lower surface of the material.

It is therefore evident that a special apparatus must be employed by which the excess of thread necessary for the formation of the stitch, but not for the stitch itself, can be withdrawn. This is effected by simply prolonging and shortening the path described by the thread in its passage from the tension apparatus to the eye of the needle. The path being shortened, a portion of the thread is at liberty for the formation of the next stitch; and on the completion of this stitch that portion of the thread which is released is withdrawn by prolonging the path of the thread. This lengthening and shortening is generally effected by giving a reciprocating motion to the eye, or bridle-rod, through which the thread passes. This motion is dependent on that of the needle and the looping apparatus, and was, therefore, formerly imparted by an eccentric groove in a disc attached to the main shaft; but owing to the difficulties attendant on obtaining exactitude by this means it is at present but seldom employed, and the moveable eye is connected either to the needle-carrier or lever.

The arrangement of the guiding-eye will be further treated of under the head of each description of machine.

III.—THE SEWING MACHINE.

Having described the mechanism of the various component parts of the sewing-machine, special arrangements of these parts will now be treated of. It is evident that owing to the various methods of construction the four principal parts of the sewing-machine may be combined in very many different ways. Their combination is, however, limited to a certain extent, inasmuch as not every arrangement, as, for instance, that of the feed motion, is adapted to the other mechanism, say of the needle. For certain purposes also the sewing plate requires to be specially adapted, involving corresponding arrangements of the lower mechanism and feed-motion. This is particularly evident in machines intended to be employed in sewing hollow articles, in which case the sewing-plate must be as narrow as possible in the direction of the feed-motion, thus precluding the use of a shuttle working otherwise than parallel to the axis of the machine, and rendering almost impracticable the application of the feed-motion from below in consequence of the limited space.

With but few exceptions all sewing-machines have but one main shaft, and the arrangements of the upper and lower mechanism and of the feed-motion are also dependent one on the other. The position of the main shaft may therefore be considered as influencing the whole of the arrangements. As a rule the feed-motion from below requires the main shaft to be placed below the sewing plate, while the feed-motion from above requires the shaft to be above the sewing plate and parallel

to the axis of the machine. Sometimes two main shafts are employed, the one above, the other below the sewing plate, in consequence of the facilities afforded in imparting motion to the needle by a shaft situated above the sewing plate, and the advantage of simplicity in the arrangements of the lower mechanism when the position of the shaft is below it. These two shafts are of course connected, generally by cog-wheels, sometimes also by cranks and connecting-rods.

In the arrangement of the mechanism facility of access to all parts must be provided for, both for the purpose of applying oil to the parts exposed to friction and of easily counteracting such irregularities in the action of the machine as may occur.

Machines to which motion is imparted by hand are generally screwed down to a table or bench (not requiring a special frame), but such machines are but little in use, as only the left hand is free for guiding the cloth, while the right soon becomes fatigued from the labour of turning. Nearly all machines are, however, provided with an arrangement for turning by hand, which is generally made use of, both to set the machine in motion, and also to retard or stop it.

Nearly all machines are now constructed with a treadle, connected to a crank, either on the main shaft or the shaft of a fly wheel, from which motion is communicated to the main shaft by driving bands. The first arrangement in which the main shaft only makes one revolution with each rise and fall of the treadle, is only applicable when, by means of cog wheels, several (three to six) stitches are made to one revolution of the

shaft. In this case it is necessary for the shaft, having the smallest wheel, to be provided with a fly wheel to compensate for the irregularity in motion.

The framework of the machine, which is now generally constructed of iron, consists of a bed plate of about 2 to $2\frac{1}{2}$ feet in length by $1\frac{1}{2}$ to 2 feet in breadth, resting on two vertical frames provided with feet and connected together by wrought-iron bars.

The treadle is constructed either of wood or iron, and is affixed to a horizontal axis, so that the axis is either below the middle of the sole of the foot when the latter is placed upon it, or behind the heel. In the first case the pressure proceeds from the front part of the foot only, while in the latter the whole of the leg, including the thigh, is brought into play. It is difficult to assign the preference to either arrangement. The axis lying below the foot divides the treadle into two parts, the front of which is double the size of the hinder. This axis consists of a wrought-iron rod connecting the two legs, about 2 to 3 in. above the ground. The angle of oscillation described by the treadle does not exceed 30 deg., and when the point of the foot is in its lowest position, the treadle still makes an angle of about 10 deg. with the ground, so that the sole of the foot never reaches a horizontal position. When the axis is placed behind the foot it consists of a wrought-iron rod about 1 to 2 in. above the ground, connecting the two front feet of the frame. The angle of oscillation of the treadle may be taken at somewhat less than 30 deg., and the treadle is in its lowest position nearly horizontal. It is thus evident that the first arrangement is best

adapted for a sitting, the latter for a standing, position.

The treadle is generally constructed with two straps for the reception of the feet, and is attached to the connecting rod by a hinge, which is a universal joint, when the axis of the treadle is not perpendicular to the axis of the fly-wheel or to the main shaft.

When the treadle is of iron, two projections are generally cast on to the hinder part, which are bored out for the axis to pass through, and the treadle is prevented moving laterally by washers and pins running through the axis. Figs. 20 and 21, Plate III., show this arrangement for two feet—Figs. 11, 12 and 14, Plate I., for one foot, when the axis lies beneath the foot; in Fig. 21, Plate IV., an iron treadle is shown; in Fig. 18, Plate III., a wooden one, the axis of both of which is behind the foot.

The position of the fly-wheel shaft depends naturally on that of the main shaft. If the fly-wheel shaft is parallel to the axis of the treadle, it is provided with a double crank, and works either in bushes, fitting into the two legs of the frame (Plate III., Figs. 20 and 21), or on points serewed through the legs (Plate III., Fig. 18), and so arranged that they become drawn tighter by use. (Plate IV., Fig. 21.)

When the fly-wheel shaft is at right angles to the axis of the treadle, a very simple universal joint is made use of, consisting of two rings of round wrought-iron (Plate IV., Fig. 21), one of which is attached to the treadle, the other to the lower end of the connecting rod.

Having concluded these introductory remarks, the

construction of the various kinds of machines will now be described *seriatim*.

A.—MACHINES WITH OSCILLATING LOOPER FOR
SINGLE-THREAD CHAIN-STITCH.

The machine shown in Plate I., Figs. 1, 2, 3 and 4, is one of somewhat antiquated construction, with feed motion from above. The space for the passage of the material is not more than $7\frac{1}{2}$ in. The axis of the machine runs from the left to the right-hand side of the worker, so that the right hand may easily reach the handle of the driving-band wheel. The direction of the feed motion is away from the worker, from the front towards the hinder part of the machine. The bent lever, *r s t*, carrying the looper *t*, admits of the lower part of the machine being constructed very narrow, so as to allow of materials of a hollow shape being sewn on it. The bracket is about 2 to 4 in. above the sewing plate, which is capable of enlargement by a flap *h*, Fig. 13. The driving shaft having a diameter of $\frac{1}{2}$ in., and parallel to the axis of the machine is situated in the upper part of the machine, which is connected with the lower part by four screws. Between the sewing plate and the oscillating looper is a space of $\frac{1}{24}$ to $\frac{1}{16}$ in. The fulcrum of the lever to which the looper is attached is situated immediately below the centre of the sewing plate, and works on the pin *s*, which is screwed through the sewing plate. The pin, *u*, against which the looper strikes for the purpose of making a lateral motion, is also provided with a screw so as to be advanced according as either it or the part of the looper striking on it become worn away. The hinder part of the

looper lever (*r*, Figs. 1, 3, 4) consists of a thin quadrangular piece, projecting $\frac{1}{2}$ to $\frac{3}{4}$ in., so that it is in contact with the lower end of the lever *q*, oscillating horizontally on a pin attached to the hinder part of the bracket, and the upper end of which is provided with a roller, acted upon by the eccentric *o*, affixed to the driving shaft. The spring *a*, pressing the hinder end of the horizontal lever from left to right, causes the ends of the two levers to remain in contact, and the roller of the perpendicular lever to remain on the eccentric. It is evident that the length of the oscillation of the looper point is entirely dependent on the shape of the eccentric. The distance, however, of the point, at the commencement of its movement, from the needle, can be readily altered by a screw inserted in the lower end of the perpendicular lever. By lengthening the screw the distance between the looper point and the needle is lessened; the looper also sooner strikes the projecting pin, thus increasing the length of the lateral movement. These two set screws are therefore the principal means of regulating the machine.

Attached to the front end of the main shaft in front of the bracket is the disc, *l*, with an eccentric groove communicating motion to the needle carrier, *h*. In front of the disc is attached a small eccentric, *d*, with a cylindrical surface, imparting the to and fro motion to the feeder, as also a roller for effecting the rise of the feeder, calculated in this instance at $\frac{5}{16}$ in. Assuming the thickest material required to be sewn on this machine to be $\frac{1}{4}$ in. in thickness, the needle carrier must not be allowed to descend so low as to touch the feeder

foot; calculating the thickness of this foot at $\frac{1}{12}$ in., the needle carrier, in its deepest position, will be $\frac{3}{8}$ in. above the surface of the sewing plate. Assuming, also, that, as is the case in the drawing, the point of the looper is $\frac{1}{8}$ in. below this surface, that at the moment of the loop being caught the eye of the needle is $\frac{1}{12}$ in. below the looper point, and that the rise for the formation of the loop is $\frac{1}{8}$ in., it follows that the length of the needle from the needle carrier to the eye is $8\frac{1}{2}$ ". If, then, the needle carrier rises this distance, the eye of the needle will just be clear of the surface of the material. Taking the point of the needle as $\frac{1}{4}$ in. long, it will therefore be necessary for the carrier to rise still 4" to enable the needle to entirely clear the material. The total rise of the carrier will therefore be $12\frac{1}{2}$ ", but 13" are generally given. This does not, however, alone determine the position and size of the eccentric slot by which motion is communicated to the carrier, Fig. 10. A line which is at all points equi-distant from both edges of the slot, is called its middle line, and everything depends on its form. The middle line of a circular slot is a circle. Let a diameter of this circle be drawn, also intersecting the centre, o , of the eccentric disc; this diameter is divided by o into two parts, M and N , the difference of which, $M - N$, is equal to the rise of the needle carrier. N also represents the shortest distance of the circle, being the middle line of the slot from the centre of the eccentric disc. Let, then, r be the radius of the roller running in the slot, $N - r$ is the shortest distance of the inside edge of the slot from the centre of the disc. Attached to the disc is, however, a

small feed eccentric, the greatest radius of which is $\frac{7}{16}$ in. It must, then, be at least $N - r = \frac{7}{16}$ in. The rollers have, however, a diameter of $\frac{3}{8}$ in., so that $r = \frac{3}{16}$ in., from which it results that $N = \frac{5}{8}$ in. But, as before shown, $M - N = \frac{1}{2}$ in., therefore $M = \frac{5}{8} + \frac{1}{2} = 1\frac{1}{4}$ in., or the diameter of the slot middle line. $D = M + N = 2\frac{1}{4}$ in., in the place of which put $D = 2\frac{1}{2}$ in., making the radius $R = 1$ in. $2''$. For the distance of the centre of the disc from that of the groove we have therefore $R - N = 1$ in. $2'' - \frac{5}{8}$ in. = $5\frac{1}{2}''$. The breadth of the slot roll is of course dependent on the diameter of the roller; its depth is $\frac{1}{4}$ in.

The eccentric situate at the hinder end of the main shaft, and by which motion is imparted to the looper, is bordered by two concentric arcs of unequal radii, running together by irregular curved lines. The difference between the radii of the two arcs determines the length of the stroke of the looper, the latter increasing proportionately with the increase of difference.

The dimensions of this eccentric have therefore to be determined, for which purpose the distance of the movement of the looper must be first ascertained. This distance may be divided into three; the first the distance of the looper point from the needle before commencing its motion = $\frac{1}{8}$ in., the second the distance from the needle to the pin effecting the lateral motion = $\frac{3}{8}$ in., and thirdly the distance of the lateral motion. To produce this lateral motion the axis of the looper must make a side movement of $\frac{1}{8}$ in. To reduce the above quantities to the motion of the looper axis, we must multiply them with the quantity $\frac{n}{m}$, m being the length of the lower lever from its fulcrum to the looper point, n the length

from the fulcrum to the axis of the looper. In the case before us $m = 5\frac{1}{2}$ in., and $n = 4\frac{1}{2}$ in., therefore $\frac{n}{m} = \frac{9}{11}$ in., and the total length of the stroke of the axis of the looper $= \frac{9}{11} \cdot \frac{1}{2} + \frac{1}{8} = 0,534$ in., for which $\frac{1}{2}$ in. is taken. The arms of the horizontal and perpendicular lever are made of the same length, so that the difference of the before-mentioned concentric arcs determining the circumference of the eccentric $= \frac{1}{2}$ in.

The needle carrier having reached its deepest point, that is when its roller stands at α in the slot of the needle-carrier eccentric, the roller, m , of the hinder perpendicular lever must leave the smaller arc of the looper eccentric. The transition to the larger arc will, therefore, have to commence in α . For the sake of simplicity we will assume the roller of the hinder perpendicular lever to move, not in a curve, but in a straight line, o, m , passing through the centre of the eccentric. The needle having risen $\frac{1}{8}$ in. the roller of the needle carrier has reached β , and the shaft has described the angle $\alpha o \beta$ as has also the looper eccentric. At this moment, however, the looper must also have advanced $\frac{1}{8}$ in. This determines the point β , if we make $o \beta = o \alpha + \frac{1}{8}$ in. We therefore draw the line $\alpha \beta$ and continue it spirally round the centre of the eccentric into the larger arc. On continuing the revolution the looper remains at its extreme point, receding quickly when the needle point has caught the loop. The longer the return motion is deferred the more certain is the loop to be caught; but it must take place sufficiently early to allow of the point of the looper passing below the eye of the needle at a distance of $\frac{1}{16}$ in. to $\frac{1}{12}$ in. At this moment the roller of the needle

carrier stands at ϵ , the centre of the roller of the looper eccentric, through which the dotted line $\alpha\beta\gamma \dots$ passes, is also at ϵ , and this point, ϵ , will be $\frac{1}{8}$ in. from the smaller arc. The smaller arc, $\alpha\zeta$, must therefore be lengthened by $\zeta\epsilon$, the latter having a radial direction. The shape of the eccentric is therefore dependent on the line thus described, its outer edge running parallel to this line at a distance equal to the radius of the roller. The eccentric has, at the point at which the quick return motion of the looper occurs, a sharp edge causing a jerk, to obviate which an eccentric groove is frequently made use of, thus dispensing with the spring pressing against the horizontal lever. The looper eccentric is moveable, being fastened only by a set screw to the axis. A slight shifting of the eccentric in the direction of the motion of the shaft causes the looper to recede earlier, but also to reach the needle sooner, thus increasing the distance between the upper surface of the looper from the eye of the needle when making its return motion, also diminishing the rise for the formation of the loop and increasing the distance between the point of the looper and the eye of the needle at the moment of the loop being caught. A contrary motion produces, of course, contrary results.

The eccentric cylindrical surface of the feed eccentric also consists of two concurrent concentric arcs. At the point where the eccentric is screwed on to the shaft the latter is $\frac{1}{4}$ in. in diameter, the radius of the smallest arc is therefore taken at $\frac{1}{4}$ in., thus giving $\frac{1}{8}$ in. thickness to the eccentric, which is found sufficient, the eccentric being constructed of steel. Assuming the greatest length of a stitch to be $\frac{1}{4}$ in., the motion of the eccentric must be $\frac{1}{8}$ in. as it presses against the feeder centrally

between its fulcrum and the roughened foot. The radius of the larger arc is therefore made $\frac{3}{8}$ to $\frac{5}{12}$ in. When the roller of the needle carrier has reached m the feed eccentric must commence its action on the feeder. The feeder being placed on the left side of its eccentric, m is the point at which the smaller curve must commence to merge into the larger one.

This transition is effected by a line running at a tangent to the smaller arc, and slightly curved at the point of concurrence with the larger one. This transition line must be so constructed as to shorten the feed motion as much as possible, that is, the centre angle $m_1 o m_2 = \psi$, between which this line lies, must be as small as possible. The transition line effecting the return motion of the feeder is constructed of the same shape as the foregoing, the return requiring also to be effected as rapidly as possible. During the return the feeder must remain in its highest position, and it therefore follows that the lower boundary of the forked lever, $c d$, which lies between a centre angle $= \psi$, must be a curve. This curve $v_1 v_2$ resolves itself on both sides into horizontal lines. The distance of the roller, b , from the centre of the eccentric disc is dependent on the extreme position of the forked lever. The exact position of the roller on the eccentric is ascertained from the condition that the feeder commences to rise when the looper has caught the loop securely. This corresponds to the moment at which the roller of the needle carrier has reached the point η in the slot. The position of the roller being fixed, the point at which the stroke of the feeder is completed and at which the horizontal return motion must commence is easily determined. From this follows the position of

the point n_1 on the feed eccentric, at which the second transition line from the larger to the smaller curve must commence.

THE SINGLE-THREAD CHAIN-STITCH MACHINE WITH
ROTATING HOOK.

The drawing in Figs. 1, 2, and 3, Plate II. describes a single-thread chain-stitch machine with rotating hook and feed motion from below. The upper and lower parts of the machine are cast in one piece, and the main shaft, b , lies beneath the sewing plate, parallel to the axis of the machine. A connecting rod, h , attached to the hinder end of the shaft transmits motion by means of an eccentric to a bent lever, i , the front edge of which is attached to the needle carrier, k . The shape of the hook has been already described; it is attached to a stud about $\frac{1}{12}$ to $\frac{1}{8}$ in. in diameter, and $\frac{1}{2}$ in. in length, fitting into the front end of the shaft, and fixed by a set screw. The eccentric, which is cast in one piece, with a small driving-wheel and fly-wheel (Fig. 5), is attached to the hinder part of the shaft. A guide ring, g , is screwed on to the shaft close to the bearing, preventing it from shifting in the direction of its axis.

A slot, c , is made in the front end of the needle-carrier lever, into which a horizontal pin, i , Fig. 12, fits. This pin is in the form of a screw, the head of which prevents a side motion of the lever, and which, prolonged and working in a slot in the bracket head, prevents the round needle carrier from turning. The presser is constructed in a similar manner to the carrier. Its foot is screwed on, and a spiral spring pressing against the bracket head effects the pressure.

The sewing plate (Fig. 6) consists of a thin steel plate, affixed to the lower part of the machine by means of two screws, *b*. The main shaft projects $\frac{1}{2}$ in. beyond the lower part of the machine, and this end is turned off in an eccentric form, and fits into a square hole in the feeder, *c*, Fig. 2. Close in front of the feeder is the looper, and on its right the stitch regulator.

The hook has a diameter of 8'''. Assuming the sewing plate to be $\frac{1}{2}$ ''' thick, and the point of the hook in its highest position to be still $\frac{1}{2}$ in. from the lower surface of the plate, it follows that the distance of the axis of the main shaft from the surface of the sewing plate = $5\frac{1}{2}$ '''. The loop-forming rise of the needle being taken at $\frac{1}{2}$ in., and the distance of the eye of the needle from the looper point at the moment of the latter catching the loop at also $\frac{1}{2}$ in., it follows that the eye of the needle when in its lowest position must stand $3\frac{1}{2}$ ''' below the surface of the sewing plate. Taking 2''' as the extreme thickness of the material to be sewn, and 2''' for the length of the point of the needle, the eye of the needle must be raised at least 4''' above the sewing-plate, to enable the needle to clear the material. Allowing, therefore, $4\frac{1}{2}$ ''', it follows that the rise of the needle carrier must be $4\frac{1}{2}$ ''' + $3\frac{1}{2}$ ''' = 8'''. The length of the needle from the carrier to the eye is equivalent to the distance of the eye from the sewing plate, the thickness of the material and that of the presser foot, which is 1''', making in all $6\frac{1}{2}$ ''', but 7''' are generally allowed. The proportions of the arms of the needle-carrier lever are as 3 to 1, the rise of the eccentric must, therefore, be $2\frac{2}{3}$ ''', or the distance of the centre of the eccentric from the axis of the main shaft $1\frac{1}{3}$ '''. The radius of the eccentric

is composed of this distance, of the length of the radius of the circumference of the main shaft $\frac{3}{16}$ in., and of the thickness of the smallest side of the eccentric $1''$, altogether $4\frac{1}{2}''$. The diameter of the eccentric is therefore $9''$. The greatest length of stitch is to be $\frac{1}{8}$ in.; the distance of the centre of the feed eccentric from the axis of the main shaft must, therefore, be $\frac{1}{3}\frac{1}{2}$ in. The stud of the looper being $\frac{1}{8}$ in. in diameter, the axis of the feed eccentric falls on it, and the radius of the feed eccentric may, therefore, be taken at $1\frac{3}{4}''$. The opening in the feeder in which the feed eccentric works is $5''$ square. In Fig. 13 the feeder is drawn separately.

MACHINES FOR DOUBLE-THREAD CHAIN-STITCH

May be divided, as before mentioned, into two classes. Machines of the first class are very similar to the single-thread chain-stitch machine with vibrating looper, and were first introduced in France, while those of the second class originated in America.

We have already examined the formation of the chain-stitch by means of two threads, and remarked that the motion of the looper corresponds exactly to that of the looper of the single-thread chain-stitch machine. The motion of the needle is also subject to the same conditions. On this account the whole of the mechanism of a single-thread chain-stitch machine can be employed in the construction of the double-thread chain-stitch machine; the shape of the looper alone varies, which involves an alteration in the length of the motion from left to right, and therefore also in the shape of the looper eccentric. The length of the movement of the looper is in this case also composed of three parts, viz.

the distance of the looper point from the needle at the commencement of its motion, which is taken at $\frac{1}{8}$ in., the distance of the movement of the looper from the needle to the stud = $\frac{5}{16}$ in., and the length of the lateral motion = $\frac{5}{32}$ in, reducing the two first motions to the fulcrum of the looper by multiplication with $\frac{5}{7}$, the proportion of the distances of the looper fulcrum and looper point from the fulcrum of the lever looper, $\frac{13}{32}$ in. results as the side movement of this point, which is also the difference of the radii of the concentric curves of which the surface of the looper eccentric is composed. This difference is, however, generally increased to $\frac{1}{2}$ in.

The tension apparatus for the lower thread is placed below the sewing plate on the hinder side α (Fig. 1, Plate I.); for facility of access an opening, indicated by the dotted line z , is left. The axis of the tension apparatus lies horizontal from left to right, the thread runs forward in the direction of the lower lever and enters the looper from left to right. On account of the shortness of the oscillations of the looper, hardly any more thread is drawn from the spool than is consumed in the completion of the stitch. A moveable thread guide is, therefore, unnecessary. In commencing the sewing the lower thread must be first drawn from the looper point through the stitch hole.

The double-thread chain-stitch machine of Grover and Baker is represented in Plate III. in two vertical sections (Figs. 1 and 2), and as seen from above (Fig. 3). The main shaft, y , is perpendicular to the axis of the machine and below the sewing plate. Affixed to it, between its two bearings, is a small driving-wheel of 1 in. in breadth, and 2 in. in diameter, and to its right

end is attached a disc, serving as eccentric for the free motion from below, and carrying a small roller $\frac{3}{8}$ in. in diameter, working in a slot of the lever arm, *c*, and communicating motion to it. This lever arm, *c*, is a part of a two-armed lever having its fulcrum at *d*, its other arm, *e*, carrying the curved needle. The needle is inserted in a semicircular groove in the needle lever, and held fast by a set screw. The lever shaft, *d*, works on screw points, and is placed as close as possible to the sewing plate, so that the curved needle may enter the material at as near a right angle as possible. These screw points facilitate the adjustment of the needle to the centre of the needle hole. The width of the slot at the extremity of the lower lever arm, *c*, is equal to the diameter of the roller working in it, viz. $\frac{3}{8}$ in. The length of this slot is rather greater than that of the rise of the needle, which is calculated as follows: In consequence of the peculiar arrangement of the moveable thread guide, hereafter to be described, the upper thread is held taut while the needle accomplishes the first $\frac{3}{16}$ in. of its ascent, and no loop can therefore be formed till this distance is completed. The ascending needle lever then also carries the thread with it in proportion as it rises, and thus, to produce a perfect loop, the needle must traverse twice the distance which would otherwise be necessary. To this distance must be added $\frac{1}{12}$ in., the distance of the looper point from the eye of the needle at the completion of the formation of the loop; $\frac{3}{16}$ in., the distance of the looper point from the needle hole plate, $\frac{1}{16}$ in., the thickness of the latter, $2\frac{1}{2}$ ''', the greatest thickness of the material to be sewn, $\frac{1}{4}$ in., the length of the needle point reckoning from the eye

and lastly, $\frac{1}{12}$ in., the height of the needle point above the material when at its extreme elevation; $1\frac{1}{4}$ in. therefore results as the rise of the needle. The half of this, or $\frac{5}{8}$ in., is the distance of the roller communicating motion to the needle lever from the centre of the disc to which it is affixed. Deducting from the above-mentioned distances the length of the needle point, $\frac{1}{4}$ in., and the rise of the needle point above the material, $\frac{1}{12}$ in., and adding $\frac{1}{12}$ in. as space for the presser foot between the material and the needle lever when in its deepest position, 1 in. results as the length of the needle from its eye to the point at which it is inserted in the lever. The looper, vibrating similarly to the balance-wheel of a watch, is attached by a screw to a spindle $\frac{5}{16}$ in. in diameter, the upper end of which works in a collar, *q*., while the conical-pointed lower end works in a socket capable of adjustment by a screw. This spindle is provided with a spiral groove constructed as follows: The round spindle is filed flat on two diametrically opposite sides, for its entire length, so that its section has the shape of the shaded part in Fig. 6, Plate III., and the centre part of it is then spirally twisted at an angle of less than 45 deg. The section of the spiral part of the spindle will, of course, be the same as that of the remaining portion, and the spindle is caused to rotate by the steel plate *a*, Fig. 6, in which is a slot corresponding to the section of the spindle. This plate fits into a groove, *b*, Fig. 5, in the lower end of the lever arm, *c*, Fig. 1. The length of the spirally-grooved part of the spindle is calculated from the arc described by the looper, which is $\frac{2}{3}$ of an entire circle. The grooves of the spindle rising at an angle of less than 45 deg. the

plate must rise exactly as much as the length of the arc described by the radius of the section of the spindle. The arc described by the looper being two-thirds of an entire circle, the length of the spindle required to be grooved = $\frac{2}{3}$ of a circle having a diameter of $\frac{5}{16}$ in. = $\frac{2}{3}$ in. At the completion of the loop, the looper has already commenced to rotate, and the point has moved $\frac{1}{8}$ in. forward, corresponding to a rise of the plate of $\frac{\frac{5}{16} \cdot \frac{1}{2}}{2} = \frac{5}{64}$, or nearly $\frac{1}{16}$ in. The lower straight part of the spindle would, therefore, be $\frac{3}{16} + \frac{3}{16} - \frac{1}{8} = \frac{5}{16}$ in. in length, the upper straight part $1\frac{1}{4} - \frac{5}{16} - \frac{2}{3} = \frac{1}{4}$ in. To the feeder (Fig. 2) is attached the roughened foot, and at *l*, a steel knee-piece working on the eccentric, and having at its left extremity a slot, in which the stud *b* fits, serving both as guide and pivot to the feeder. Between a projection on the lower side of the sewing plate, *d*, and one on the upper side of the feeder, *c*, is a spiral spring, by which the feeder is kept in contact with its eccentric. In another slot of the feeder (*a*) is the stitch regulator, the arrangement of which is shown in Fig. 13. It is centred on a screw, *d*, and presses, by its elasticity, the stud, *e*, at its other extremity, into the holes, *f*, by which it is secured in its position. The surface of the feed eccentric is so constructed that the roughened plate commences its motion for the length of the stitch at the moment of the needle reaching its highest point and being about to descend. Just before the feeder commences the horizontal motion it rises $\frac{1}{12}$ in., and immediately the horizontal motion is completed it again descends $\frac{1}{12}$ in., and makes its return motion while the main shaft is completing its revolution. The shape of the cylindrical surface of the feeder is shown in Fig. 7, of

the grooved surface in Fig. 8, in which the spiral grooves are represented by *d, e, a, b, c, d*. In both drawings those parts of the surface which are at the same moment in contact with the feeder are marked with the same letters. While *a b*, Fig. 7, by which the transition of the curve, *d, e, a*, into the layer curve, *b c*, is effected, raises the feeder $\frac{1}{12}$ in., *a b*, in Fig. 8, prevents the horizontal motion of the feeder, which commences between *b* and *c*. During this time, *b c*, of Fig. 7, prevents the vertical motion, and only on the completion of the horizontal motion between *c* and *d*, Fig. 8, is the descent possible, on the completion of which the return motion is effected between *d* and *a*, Fig. 8, during which the curve, *d, e, a*, Fig. 7, retains the feeder in its lowest position. The presser, *l*, Figs. 1, 2, and 10, consists of a bent steel plate, working in a guide in the head of the bracket arm, in which is also the socket for the reception of a spiral spring acting on a pin brazed on to the presser. In the upper end of the presser is a slot, in which the disengagement, *x*, works. The presser, together with the spiral spring and disengagement, must be inserted in the bracket arm before this is screwed on to the bed plate of the machine. The presser foot has a forked shape, dependent on the shape of the serrated plate, Plate III., Fig. 4. The shape of the opening in the needle-hole plate is dependent on the shape of this plate and the size of the longest stitch to be made. The needle hole has a diameter of $\frac{1}{12}$ in., and is enlarged on its lower side, Fig. 9.

The reel, on which is the lower thread, runs loosely on a thin, horizontal spindle attached to the lower side of the table; from it the thread is conveyed to the

tension apparatus, *w*, Fig. 3, and from thence to the looper.

The same tension apparatus is applied to the upper thread, which, however, is then conveyed through a slit in the rod *k*, round which is a thin spiral spring of brass pressing the thread gently in an upward direction. This arrangement is shown in full size, Fig. 12. A T-shaped steel plate, *h*, Fig. 11, together with another similar-formed piece, but with only one arm, are attached by a screw to the needle lever. Their projecting arms are covered with cloth at their point of contact, and between them the thread coming from the spiral spring is held tight when the needle has completed $\frac{3}{16}$ in. of its ascent, as otherwise the thread would be held taut by the spiral spring, thus preventing the formation of the loop. This apparatus, rising however with the needle lever, draws the thread with it, only however to the extent of half the quantity set free by the ascent of the needle, and it is on this account that the ascent of the needle for the formation of the loop must be made double as long as would otherwise be necessary.

D.—MACHINES FOR QUILTING-STITCH, WITH MOVEABLE SHUTTLES.

The first machine of this description was constructed in 1834, in America, by Walter Hunt; but although the principle was the same as that now employed, yet defects in the mechanical arrangements prevented its application till 1846, in which year Elias Howe introduced a similarly-constructed machine with great success. This machine was still further improved upon by Singer, of New York, who first introduced the method

of imparting motion to the shuttle by a crank and connecting rod.

1. SINGER'S SYSTEM.

Singer's machine is shown in Plate IV., Figs. 1, 2, 3, and 4. It has two driving shafts parallel with the axis of the machine, one of which is above, the other below the sewing plate. Cog-wheels are generally affixed to these shafts, driven by a larger wheel, which is generally cast in one piece with the sheave of the machine. This arrangement is shown in Fig. 18, Plate III. The following arrangement is shown in Figs. 1, 2, 3, 4, Plate IV. To the hinder-ends of the two driving shafts are attached two sheaves of $3\frac{3}{4}$ in. diameter, each provided with a stud, at a distance of $1\frac{1}{2}$ in. from its centre. A perfectly similar sheave works on a pin attached to the lower part of the machine, parallel and at the same level as the lower driving shaft, and at a distance of $4\frac{1}{2}$ in. from it. The studs of these three discs are connected together by a cast-iron triangle, communicating the rotary motion of the lower to the upper sheave. To prevent the occurrence of a dead point, the third disc is introduced; for a dead point occurring in the position of the two main shafts, as is shown in Fig. 3, Plate IV, the lower shaft still presses against the stud of the third disc, and this pressure is transmitted to the upper sheave, and an equable motion is thus produced. In the front of the upper shaft is a disc having a roller attached, working in a kidney-shaped groove in the needle carrier. The shuttle is propelled by a crank on the lower shaft by means of a connecting rod. The driver is, as shown in Fig. 1, constructed of two pieces screwed

together, the lower of which has a long continuation the lower end of which is exactly on a level with the lower shaft, so that the connecting-rod, acting on this end, moves in a horizontal direction. The driver has, on both sides, projections, between which the shuttle lies; the one on the left side, *a*, Fig. 18, acting on the heel of the shuttle remains $\frac{1}{8} - \frac{3}{16}$ in. from the guide plate, which facilitates the tightening of the loop of the upper thread when the shuttle has passed through it, as the thread of the loop must pass between the projection, *a*, and the heel of the shuttle. The front projection, *b*, fits into a corresponding cavity, *p*, in the upper surface of the shuttle point, and effects the return motion of the shuttle. The latter has about $\frac{1}{12}$ in. play between the two projections of the driver, so that when the projection, *a*, is in contact with the shuttle, there is sufficient space between the projection, *b*, and the shuttle point to allow the thread of the loop to pass freely, as shown in Fig. 22, A. This shape of the driver has the advantage over others which will be described later, that the pressure of the projection on the point does not cause an increase of friction between the shuttle and the guides. The driver is sometimes constructed of brass, sometimes of cast-iron.

The shuttle has a length of $2\frac{1}{4}$ in. Its point being at the commencement of the motion, $\frac{1}{4}$ in. distant from the needle, Fig. 22, E, and its heel having at the conclusion of the stroke exactly escaped the needle, Fig. 22, C, $2\frac{1}{2}$ in. result as the length of the motion of the shuttle, giving $1\frac{1}{4}$ in. for the length of the driving crank. The needle after penetrating the material enters a groove in the shuttle guide, intended to protect the needle, and varying

W
1

THE VARIOUS DESCRIPTIONS OF MACHINES:

from $\frac{1}{12}$ to $\frac{1}{16}$ in. in width, and of at least the same depth. The needle must fit into the groove so that the shuttle passes close to it without touching. If the needle is too far back the shuttle is apt to miss the loop, and if it projects either it or the shuttle point is liable to injury. If we imagine the shuttle in the middle of the loop of the upper thread the thread would be caught between the shuttle and the guide, the latter is therefore slightly hollowed out, *k*, Fig. 18.

To determine the form of the kidney-shaped groove in the needle carrier we must revert to the motion of the needle and shuttle which are dependent one on the other. The piece containing the groove is shown in Fig. 20. The centre of the roller driving the needle carrier describes the line *k c d e*. In Fig. 19 the inner circle shows the path described by the roller. The outer one, that described by the crank, imparting motion to the shuttle. The direction of the motion is shown by the two arrows, and the numbers 1, 2, 3, 4 and 5, the cotemporary positions of the roller and crank, to which again the relative positions of the needle and shuttle in Fig. 22, A, B, C, D, and E, correspond. The line *k c d e* consists of three parts, of two straight lines, *k c* and *d e*, and of a curved line, *c d*. It is evident that the points *k* and *e* must be at the same distance from the perpendicular axis of the needle carrier as the roller is from the axis of the upper main shaft. Imagining the roller to commence its motion at *k*, it will, on arriving at 5, have depressed the needle carrier, *h*, 5. On passing 5 it again raises the needle and has, on arriving at 1, raised it sufficiently for the formation of the loop, so that the needle can remain stationary. As

the ascent necessary for the formation of the loop is $\frac{1}{8}$ in., the difference between $5 h$ and $1 c$ must also be $\frac{1}{8}$ in. The length of $5 h$ is ascertained from the position of 5 in the circle described by the roller, and this is determined by the curve, $5 k$, being half a right angle. The length of $5 h$ being found it follows that $1 c = 5 h$, $-\frac{1}{8}$ in., and from this the position of 1 is determined. The corresponding point in the crank circle is derived from the condition that the shuttle must have accomplished the first $\frac{1}{4}$ in. of its motion when the needle has formed the loop. The needle commences slowly to ascend when the shuttle has completed its motion, at the moment the shuttle has reached the point shown in B, Fig. 22. This gives the position of 2 on the crank, and of the corresponding point on the roller circle, from which follows the end, d , of the curve described round the centre, b ($a b = 1 c$), with the diameter of the roller circle. The line $d c$ forms the rectilinear continuation of this curve, so that the central line of the kidney-shaped groove is now complete. The shuttle having completed its advance the needle rises, Fig. 22, C, and having reached its highest point, 4 , the shuttle has already commenced its return motion, Fig. 22, D, which being completed, the needle has again reached its deepest point, Fig. 22, E. It now only remains to determine the diameter of the circle described by the roller. The ascent of the needle is composed of the distance necessary for the formation of the loop, and the diameter of the before-mentioned circle, or the diameter is equal to the difference of the ascent of the needle, and the portion necessary for the formation of the loop. We must, therefore, first determine the distance of the ascent.

The depth of the shuttle is $\frac{7}{16}$ in., its upper edge is $\frac{1}{16}$ in. below the needle-hole plate, which is $\frac{1}{16}$ in. thick; assuming, then, that the eye of the needle, when in its deepest position, is $\frac{3}{16}$ in. below the lower edge of the shuttle, the thickest material to be sewn to be $\frac{5}{16}$ in., the point of the needle $\frac{1}{4}$ in. long, and required to be, when in its highest position, $\frac{1}{16}$ in. above the material, it follows that the total distance of the ascending motion is $1\frac{3}{8}$ in., and deducting $\frac{1}{8}$ in. for the ascent necessary for the formation of the loop, the diameter of the above-mentioned circle results = $1\frac{1}{4}$ in.

The disc, on which is the roller communicating motion to the needle-carrier, is permanently attached to the end of the upper shaft; the crank, however, by which the shuttle is actuated, is fastened by a screw to allow the regulation of the period of the shuttle point in its advance reaching the needle.

The feed motion is effected by a wheel, provided with the arrangements before described. The one end of the shaft carrying the two levers, one of which is attached to the connecting-rod, the other to an eccentric on the lower main shaft, runs on a bearing, Fig. 4, attached to the framework of the lower part of the machine, while the other works on the point of a screw, so as to allow of the shaft being easily removed and replaced. This shaft is frequently of cast-iron, in one piece with the levers. The eccentric transmitting motion to the feed mechanism also consists of a crank, Fig. 17. The lever, *v*, Fig. 2, actuated by this eccentric, has attached to its upper sides a perpendicular stud, coming periodically in contact with the spiral stitch-regulator. The eccentric rise on the crank (*a*, Fig. 17) results from the proportions

of the lever arrangement, and from the greatest length of stitch which has been taken, as $\frac{1}{4}$ in. in $\frac{3}{8}$ in.

The stitch-regulator, Fig. 16, is provided with an index-plate, *a*, and is set by a corresponding key, *c*. The construction of the presser has been before described. The tension apparatus consists of a roller round which the thread is wound more or less often, Figs. 1 and 5, and the reel, *w*, carrying the thread, runs loose on an upright spindle.

Attached to the lower shaft is a driving-wheel, *e*, Fig. 1, the diameter of which is four to five times smaller than that of the corresponding driving-wheel, *k*, Fig. 21, on the fly-wheel shaft. The driving band is $1\frac{1}{2}$ to 2 in. in breadth, and the upper driving-wheel is 2 in. in diameter. If, however, the two shafts are connected by cog-wheels, both the upper and lower driving-wheels have a diameter of 5 in., and the revolutions of the cog-wheels are as 5 to 1, or 4 to 1. The cog-wheels are divided into $\frac{1}{4}$ in., so that the strength of the teeth is $\frac{1}{8}$ in. on the periphery, with a width of $\frac{1}{2}$ in.

Machines of this construction are capable of making 700 stitches a minute, even on the thickest materials, as leather, and are, therefore, much employed in the manufacture of shoes, saddlery; and on account of the large space available for the passage of the material, are particularly adapted for sewing mantles, coats, etc.

In commencing the sewing the machine is allowed to make one revolution before the material is inserted, so that the upper thread, the end of which is held in the hand, may catch the lower thread and draw it through the needle-hole.

2. HOFMANN'S SYSTEM.

The arrangement of this machine is shown in Figs. 1 and 2, Plate V. The space for the passage of the material is only 7 in., and the material passes from the right to the left of the machine. There is only one main shaft lying below the sewing-plate, parallel to the axis of the machine, working on bearings, the hinder one of which is conically enlarged on both sides to prevent the shaft from shifting in the direction of its axis, and must, therefore, be provided with a cap. The shaft itself is provided near its front end with a crank, to which is attached a connecting-rod, imparting motion to the shuttle-driver. To the hinder end of the shaft is attached a cylinder with an eccentric groove, *g*, Figs. 1 and 2, acting upon a bent lever, *klm*, either communicating motion to the needle-lever by means of a connecting-rod, or acting direct on a stud affixed to the needle-lever.

The shuttle, shuttle-race, shuttle-driver, &c., are constructed similarly to those of the machine last described, except that the point of the shuttle lies higher $\frac{3}{16}$ in. above the lower edge of the shuttle, so that $\frac{1}{8}$ in. may be given for the formation of the loop, and $\frac{1}{8}$ in. for the distance of the shuttle-point from the eye of the needle at the moment of the loop being caught. The distance traversed by the shuttle is, therefore, in this case $2\frac{1}{2}$ in., and the crank on the main shaft must therefore be $1\frac{1}{4}$ in. When the needle is at its deepest point its eye is $\frac{1}{16}$ in. below the lower edge of the shuttle; the shuttle is $\frac{7}{16}$ in. in depth; the distance of the upper edge of the shuttle from the $\frac{1}{16}$ in. thick needle-hole plate is $\frac{1}{16}$ in. Assuming $\frac{1}{4}$ in. for the thickest material to be sewn, $\frac{1}{4}$ in. for the needle-point, and $\frac{1}{16}$ in. for the distance the point

of the needle is withdrawn from the material, $1\frac{3}{16}$ in. results as the total rise of the needle. Deducting from this $\frac{1}{4}$ in. the length of the needle-point, and $\frac{1}{16}$ in. for the distance of the needle-point from the material, and adding $\frac{1}{8}$ in. for the space necessary for the presser, between the needle-carrier and the material, 1 in. results as the length of the needle from the needle-carrier to the eye.

To describe the path of the eccentric groove, let us imagine the surface of the cylinder as a plane. The arms of the bent lever connecting the groove with the needle-carrier being proportioned as 6 to 5, the roller must describe five-sixths of the distance traversed by the needle, and it therefore follows that the middle line of the groove, moving from right to left, must always rise and fall five-sixth of the distance of the motion of the needle. Assuming the needle to be at its lowest point, the roller will stand at 1, Fig. 17. The inner circle shown in Fig. 16 presents the path described by the crank, and the numbers correspond with those in Fig. 17, indicating the relative position of the crank, while those on the straight line in Fig. 16 indicate the position of the shuttle. On the shuttle advancing to 2, the crank has also made a similar advance, as has also the roller, so that the corresponding ordinate must be $1\frac{1}{4}$ ". While the point of the shuttle is entering the loop the needle must again have descended $\frac{1}{8}$ in. ; but the distance, 23, corresponding to the curve, 23, described by the crank, the curved piece, 23, results. The needle now remains stationary till the shuttle has penetrated the loop ; this corresponds to the curve, 34, or the distance, 34. The needle must then rise sufficiently quick

to allow the eye of the needle to have ascended above the needle-hole when the cylindrical point of the shuttle has reached the perpendicular groove in the shuttle-race. This occurs when the crank has traversed the curve, 45, corresponding to the distance, 45. The needle then ascends till it reaches its highest point and descends, so that it reaches its lowest point on the completion of the revolution of the cylinder with the eccentric groove. The fulcrum of the bent lever is perpendicular above the central position of the roller, and the roller being attached to a lever, and, therefore, moving in a curve, the lever must be made sufficiently long to allow the roller to rise the same distance above the level of the axis of the main shaft as it descends below.

The feed motion from below consists of a serrated plate put in motion by the feed eccentric, γ , attached to the main shaft. This eccentric is composed of two eccentric cylindrical surfaces joined together, Fig. 16. The one by which the ascent of the feeder is effected must have a radial difference of $\frac{1}{2}$ in., the other of $\frac{1}{4}$ in., the length of the longest stitch. The shaft being $\frac{5}{8}$ in. in diameter, the radius of the smallest curve may be taken at $\frac{5}{12}$ in. from which the other radii may be easily determined. The rise, advance, and fall of the feeder succeed each other rapidly. The feeder commences to rise with the surface, $a b$; this rise terminates on the point, b , standing perpendicular above the axis.

At this moment the advance commences; at the point b , when the angle, $b o b$, is a right angle, the transition of the cylinder to the greater radius must take place. On the point c reaching the position occupied by b , at the commencement of the advance, the advance

is completed, and the descent commences, that is, the point c , is then perpendicular above the axis. When d has reached this position the return can commence, that is at the point d ($\angle d o d$ is a right angle; $\angle 603 = 405$) the transition from the larger to the smaller curve takes place.

3. GROVER AND BAKER'S SYSTEM.

The construction of these machines being similar to that of the one just described, only the mechanism of the lower part is shown in Plate V. The bracket arm is hollow, and is attached to the bed by four screws. The driving shaft is below the sewing-plate, parallel to the axis of the machine, and runs on bearings, the hinder one of which is provided with a cap. Attached to the hinder end of this shaft is a fly-wheel, with which a driving-sheave is combined, and also two cylinders with eccentric grooves, transmitting motion, one to the shuttle, the other to the needle carrier. The bent lever, by which the shuttle is actuated (Figs. 20 and 21) has attached to it the driver, constructed of cast-steel. The shuttle race, which must be curved, corresponding to the motion of the shuttle and driver, is represented in Fig. 19.

A screw bolt, g , Figs 20 and 21, forms the fulcrum of the shuttle lever, and is screwed on to a piece of wrought-iron attached by two screws to the sewing-plate. The proportion of the lever arm carrying the driver and the roller is as 3 to 1, so that the curve described by the eccentric grooves communicating motion to the shuttle is three times flatter than it would be with arms.

The bent lever, transmitting motion from the other eccentric to the needle carrier, and vibrating in a per-

pendicular plane, has two arms, the length of which are proportioned as 6 to 5, and works on the pin, *l*, Fig. 24, screwed to the bracket arm. It is entirely covered by the hollow bracket, the left side of which is closed by a slide fastened by two screws.

The grooves of the eccentric are so arranged, that for every revolution of the driving shaft two strokes of the needle and of the shuttle are completed, therefore also two stitches. The shuttle is $2\frac{1}{4}$ in. in length, and its point being, when in its extreme position, to the left, $\frac{1}{4}$ in from the needle, the length of the motion of the shuttle will be $2\frac{1}{2}$ in., and the vibrations of the lever roller will, therefore, only be 10 ". The diameter of the cylindrical part of the shuttle is $\frac{3}{8}$ in., and between it and the $\frac{1}{16}$ in. thick needle-hole plate is a space of $\frac{1}{16}$. The shuttle point lies, therefore, $\frac{5}{16}$ in. below the surface of the sewing plate, and the needle eye, when in its deepest position, is $\frac{2}{4}\frac{5}{8}$ in. below the surface, reckoning 1 " for the ascent necessary for the formation of the loop, and $\frac{1}{8}$ in. for the space between the shuttle point and needle eye on the formation of the loop. Allowing further $\frac{1}{4}$ in. for the thickest material to be sewn, $\frac{3}{16}$ in. for the length of the needle point calculated from the eye, and $\frac{1}{2}$ in. for the space required to be left between the needle when in its highest position, and the material, 1 in. results for the rise of the needle carrier; which is, however, generally taken at $\frac{5}{4}$ in.

The grooves of the eccentric, Figs. 22 and 23, are composed of two perfectly similar halves, and it is therefore only necessary to describe the path of one of them. The grooves have a motion in the direction of the arrow;

the rollers will, therefore, move in these grooves in a contrary direction, so that we may commence with the corresponding point, 1. The points reached by the rollers at corresponding periods are always in a curve of 90 deg. from one another. While the rise necessary for the formation of the loop is being effected by the needle, which moves for this purpose to 2, the shuttle point has advanced $\frac{1}{4}$ in., so that it has reached the needle, that is the groove of the shuttle eccentric has risen $\frac{1}{1\frac{1}{2}}$ in., and arrived at 2. While there the shuttle is advancing till it has completed its advance at 3. The needle has remained stationary to the same point, and the shuttle then ceases its motion till the needle has risen to 4. The shuttle then commences its return which is complete to 5, in the same time as the needle finishes the ascent to its highest and again descends to its lowest point at 5.

The feed motion from below consists in a moveable plate set in motion by a feed eccentric attached to the main shaft by a set screw. This eccentric must naturally also complete two advances to each revolution of the main shaft. The construction of this eccentric, Fig. 18, has been already described.

The driving sheave, attached to a small fly-wheel situate at the hinder end of the main shaft, has a diameter of 4 to 5 in., while that attached and cast in one piece with the large fly-wheel, the shaft of which is below the sewing-plate, has a diameter of 8 to 10 in. Each revolution of the main shaft completing two stitches, it therefore follows that four stitches are completed to each ascent of the treadle, or about 700 stitches to a minute.

THOMAS'S SYSTEM.

These machines are arranged for sewing materials having a hollow form, and the lower part *b*, Figs. 1, 2, 3, and 4, Plate VI., therefore, consists of a thin, narrow arm projecting horizontally above the surface of the table, to which it is attached by the screw, passing through a tripod *a*, on its hinder end. The axis of the machine is parallel with the arm, and the upper part, *c*, of the machine is connected with the lower by two strong $\frac{3}{8}$ in. screws, *t*. The main shaft, *u*, lies behind, perpendicular to the axis of the machine, and somewhat below the sewing plate, which latter is about 5 in. above the lower part of the machine. Attached to the shaft on the right side of the axis of the machine is a large disc with two eccentric grooves, the one effecting the motion of the needle, the other that of the shuttle. On the left side is the feed eccentric, *p q*, imparting motion by a combination of levers to the feed above.

The driver, *c*, Figs. 4, 5, and 9, constructed of brass, seldom of iron, works in guides of which the slot, *k l*, Fig. 1, $\frac{1}{3}$ in. broad, and 1 in. deep, may be considered a continuation. In this slot *k* works, $\frac{5}{4}$ in. in length, having attached to it at one end the roller, *m*, on a horizontal pivot, at the other end, connected with the driver by a round rod, *h*, $\frac{1}{4}$ in. in diameter.

A wrought-iron lever $\alpha y \beta$, with two equal arms, the fulcrum of which is *y*, transmits the motion of the second eccentric groove to the needle lever. For this purpose the hinder lever-arm carries a roller, α , on a horizontal pin, the other lever arm being forked and acting on a stud projecting horizontally from the needle carrier, $\pi \rho$.

The length of the shuttle is here also $2\frac{1}{4}$ in., and its stroke, $2\frac{1}{2}$ in. The shuttle being $\frac{7}{8}$ in. in depth, its upper surface being $\frac{1}{6}$ in. distant from the lower surface of the needle-hole plate, which is also $\frac{1}{8}$ in. thick, the thickest material being $\frac{1}{4}$ in. allowing $\frac{1}{4}$ in. for the needle point, $\frac{1}{6}$ in. for the space left between the needle point and the material, and $\frac{1}{6}$ in. for the space between the eye of the needle and the lower edge of the shuttle, $1\frac{1}{8}$ in. results as the length of the stroke of the needle carrier. Taking into consideration that the feeder foot requires $\frac{1}{8}$ in. space between the material and the lower part of the needle lever, 1 in. results as the length of the needle from its point of insertion to its eye.

The corresponding positions of needle and shuttle afford the data for the construction of the eccentric slots. We begin with those parts of the grooves corresponding to the moment at which the needle and shuttle commence their motion. Assuming $\frac{3}{4}$ in. as the diameter of the main shaft, and $\frac{3}{8}$ in. as the diameter of the roller, the inner and smaller groove by which the shuttle is driven will be $\frac{1}{6}$ in. from the centre of the disc at the point where it is nearest to it, and (the throw of the shuttle being $2\frac{1}{2}$ in.) $3\frac{5}{6}$ in. where it is at its greatest distance from it. The rollers of the needle lever and shuttle driver occupy at corresponding periods the positions indicated on their respective slots by corresponding numbers. We commence with the points 1, placed at an angle of 90 deg. from each other, as are all the other corresponding points. We will describe the roller of the needle lever as "*first*," that of the shuttle driver as "*second*" roller. The first roller having reached the point 2, the radius of which is shortened

$\frac{1}{12} - \frac{1}{8}$ in., the distance of the rise necessary for the formation of the loop, the second roller has also reached the point 2, the radius of which is shortened $\frac{1}{4}$ in., as the shuttle point was at first $\frac{1}{4}$ in. removed from the needle. The path 23 of the first roller is symmetrical with 12, the needle sinking the same distance as it had risen; in the same time the second roller has reached point 3, the radius of which is again shortened the length of the shuttle point as the cylindrical part of the shuttle must then just have reached the needle. The groove of the second roller now continues to approach the centre of the disc to point 4, corresponding with the position of the shuttle after the completion of its stroke. Till this moment, the needle has remained stationary, on which account 34 of the path of the first roller is circular shaped. From 4, the larger groove has only to fulfil the condition that its radius shall diminish as much as requisite, increasing on its return to point 1. The groove can therefore be symmetrical, and the axis of symmetry is found by connecting the centre of the disc with point 2. The point *a* of the groove, where the smallest radius occurs, must also lie in this axis. When the first roller has reached point 4, the shuttle must stand still till the eye of the needle has reached the sewing plate, this corresponds to the point 5 in the groove of the second roller. The piece 45 of the inner groove consists, therefore, of a concentric curve. The inner curve from 5 having no other condition to fulfil but that its radius should again increase to point 1, may also be made symmetrical. The curve 45 is halved, this central point connected with the centre of the disc, giving the axis of symmetry. The con-

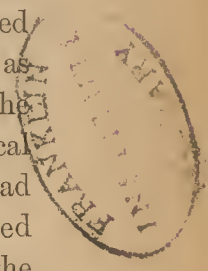

centric curve $1e$ having the radius, 01 is described. The choice of the point 1 is of importance for the size of the exterior curve. It is of course brought as near the inner curve as possible, but only so near that there may be at least $\frac{1}{4}$ in. between the two grooves at their nearest points.

The disc is screwed on to the shaft which runs on a bearing 2 in. long. The other end of this shaft carries the feed eccentric, pq . Attached to the extreme end of the main shaft is the driving sheave.

The feed eccentric imparts motion to the feeder by means of a two-armed lever, $\mu z \nu$, moving in a perpendicular plane, having its fulcrum at z , and a lever shaft, e , Fig. 15, running on screw points. The feeder arm, λ , Fig. 1, runs in a slot in the bracket arm, $\frac{3}{16}$ in. broad and $\frac{3}{4}$ in. deep, and is forked at its upper extremity. A flat spring presses against the feeder from left to right. The front end of the lever vibrating perpendicularly is attached to the feeder, being pressed downwards by a spiral spring attached to ξ and σ . At its hinder end, on a horizontal pin, is a roller travelling on the cylindrical edge of the eccentric, thus effecting the rise and fall of the feeder. The *lever shaft*, Fig. 15, that is a shaft running parallel with the axis of the machine, has attached to both ends, and perpendicular to it, levers, the one of which, a , carries a rotating roller, c , working on the second screw-shaped surface of the feed eccentric, while the other, b , has affixed to its lower end a horizontal projecting stud, shown in Fig. 12, pressing the feeder from right to left, effecting its backward and forward motion. The stitch regulator acts on the

hinder lever of the lever shaft, and the arrangement is shown clearly in Fig. 8.

The feed motion just described only allows of the material when of a hollow shape, as coat-sleeves, uppers of boots, &c., being sewn round. But it is often necessary to sew these articles also longitudinally, and a second feed motion is therefore introduced, by which the material is advanced from the front towards the hinder part of the machine. This feeder is similarly constructed to the one just described, having for its guide the perpendicular groove, κ in the head of the bracket. The shape of this feeder is shown in Fig. 11, while that of the first is represented in Fig. 10. A spring presses this feeder towards the front of the machine, and for the purpose of imparting the requisite motion, the front lever of the lever shaft has affixed to its lower end, d , Fig. 12, not only the stud, e , but also a conical piece, e , acting upon the second feeder, and giving it a forward motion. Of course both feeders cannot be employed at the same time.

This machine is especially applicable to saddlers' work, the manufacture of boots, shoes, &c. The feed motion from above allows of very sharp curves being made, which are requisite in ornamenting the fronts of shoes, slippers, &c.

THE QUILTING-STITCH MACHINE WITH FIXED BOBBIN.

The lower part of the machine, Figs. 1, 2, and 3, Plate VII., consists of a cast-iron plate, a , provided with two bearings, b and d , in which the main shaft works, carrying the looper, f , constructed of steel. Between

these bearings is a cast-iron cylindrical piece, β , cast in one piece, with the feed eccentric, γ , and the eccentric, r , for imparting motion to the needle by means of the needle lever, $q s$, working on the screw points, $v v$.

Close beneath the sewing plate, above and parallel to the main shaft, is the wrought-iron piece, $\varepsilon \varepsilon$, working in a guide in the direction of the shaft. This piece (shown in Fig. 21) has a slot in the same direction, in which is a steel tongue, the right end of which is the serrated feeder foot, c , while the left end is fastened by a pin, e , in the slot. The rise of the tongue is effected by the feed eccentric pressing against the projection, b , the descent by its own weight. The forward motion is effected by the eccentric pressing against the carrier, $\varepsilon \varepsilon$, and the return by a spiral spring. The stitch regulator, δ , Figs. 1, 2, 3, and Fig. 6, provided with an index, is inserted in the sewing plate to the left behind the feeder carrier.

The break or drag, Fig. 5, pressing against the cylindrical surface of the looper, consists generally of a small brush, less frequently of a piece of leather, and is attached by the screw, d , to an iron piece in the plate, a , which is screwed on to the right side of the right bearing, so that the brush may act upon the looper as before described.

The spool or the shuttle is fitted in a recess of the looper, and to prevent its falling out, the so-called eye-piece is employed, Fig. 8, consisting of a circular cast-iron ring having the same axis as the main shaft, attached at right angles to the carrier, d , on the lower surface of which is the guide, c , working in a corresponding slot in the bed-plate. This carrier is affixed

to the bed-plate by a thumb-screw, and has at its hinder end a projection, *f*, which is also provided with a screw by which the distance of the eye-piece from the looper is regulated.

The spool has a diameter of 14"', which is also that of the periphery of the eye-piece. To facilitate the passage of the thread, the eye-piece is filed flat at the points, *b* and *c*; *b*, the section of which is shown, is the point at which the thread enters between the spool and the eye-piece, while *c* is the point at which the loop is detained by the drag, and drawn tight.

The eccentric, Fig. 15, attached to the main shaft, actuates by means of a connecting rod the lower end of the perpendicular arm of the needle lever. This arm is not, however, cast on to the lever axis, but so screwed on that it can be lengthened or shortened at will by means of a $\frac{3}{8}$ in. screw, *t*, Figs. 1, 2, and 3. The rise of the needle can be thus regulated, as also the space between the eye of the needle and the looper point, at the moment of the latter entering the loop of the upper thread.

The needle hole, Fig. 12, has a diameter of $\frac{1}{16}$ in., and is enlarged conically in a downward direction. It is the termination of the slot, *ab*, $\frac{1}{32}$ in. in breadth, by means of which the lower thread is conducted through the needle hole before commencing to sew.

The two screw points, on which the needle lever works, serve to keep the needle true to the centre of the needle hole. The needle lever vibrates on the left side of the bracket head, and generally has the tension apparatus, *gf*, attached to its hinder end close to its fulcrum.

The driving wheel attached to the fly-wheel shaft is $7\frac{1}{2}$ in. in diameter, enabling 1000 stitches to be completed in a minute. Owing to the slight tension necessary, very thin thread can be employed, and these two qualities, combined with the almost perfect noiselessness of the machine, make it the most adapted for use in private families, and for every description of light work. It is, however, the most difficult to learn the use of, and great nicety is required in the construction of the various parts.

THE END.

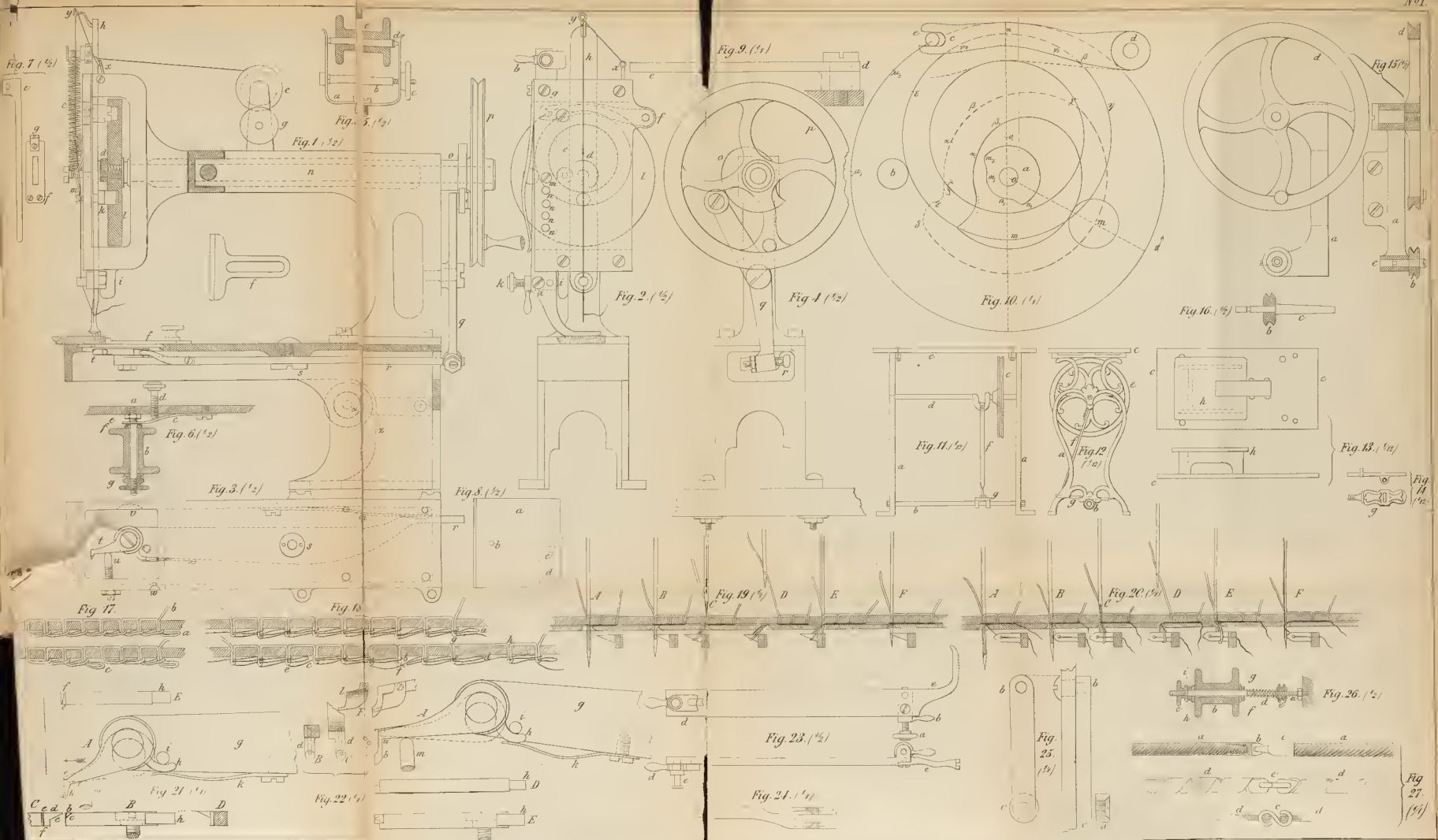

Fl.

of
①
/

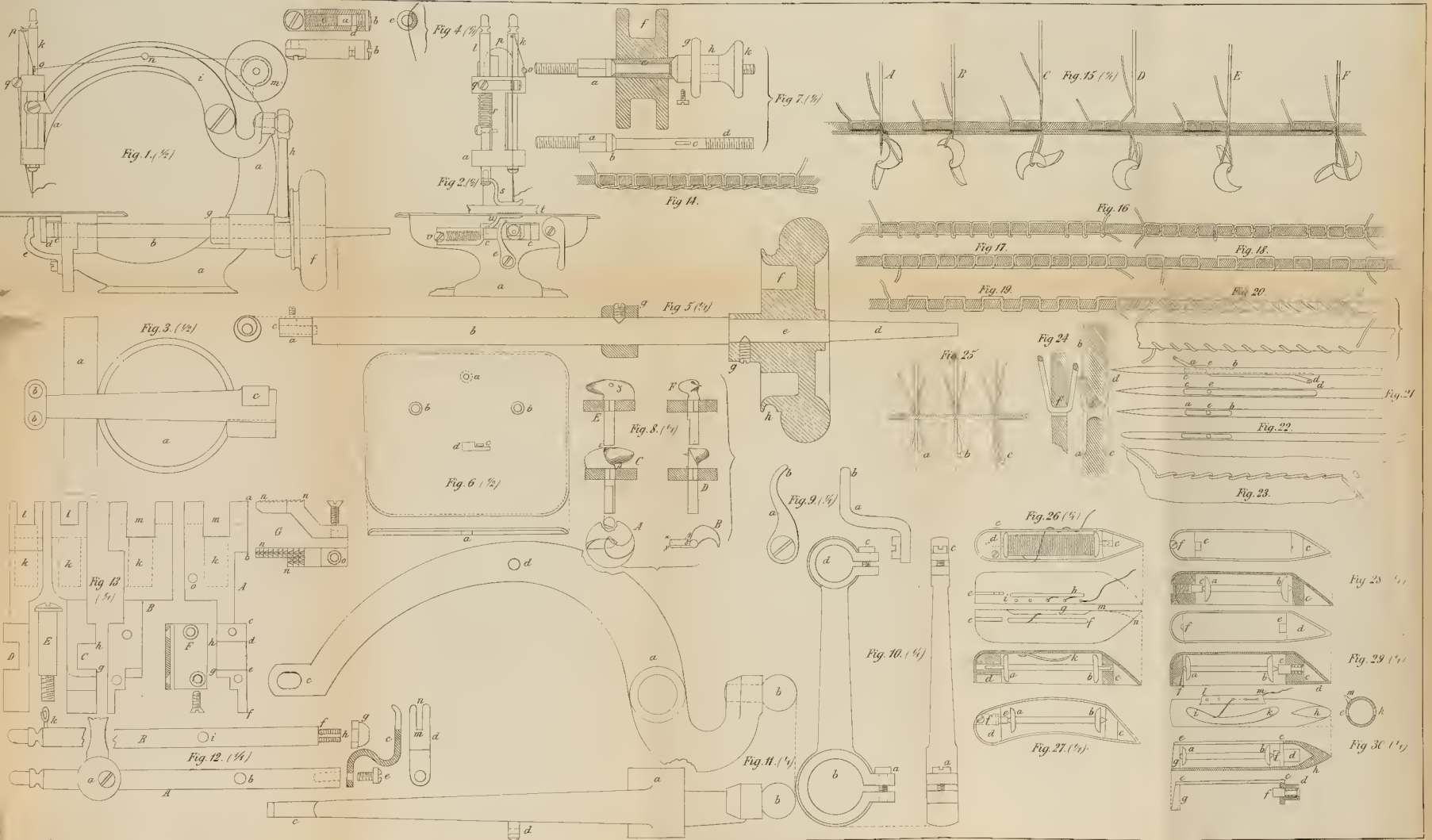

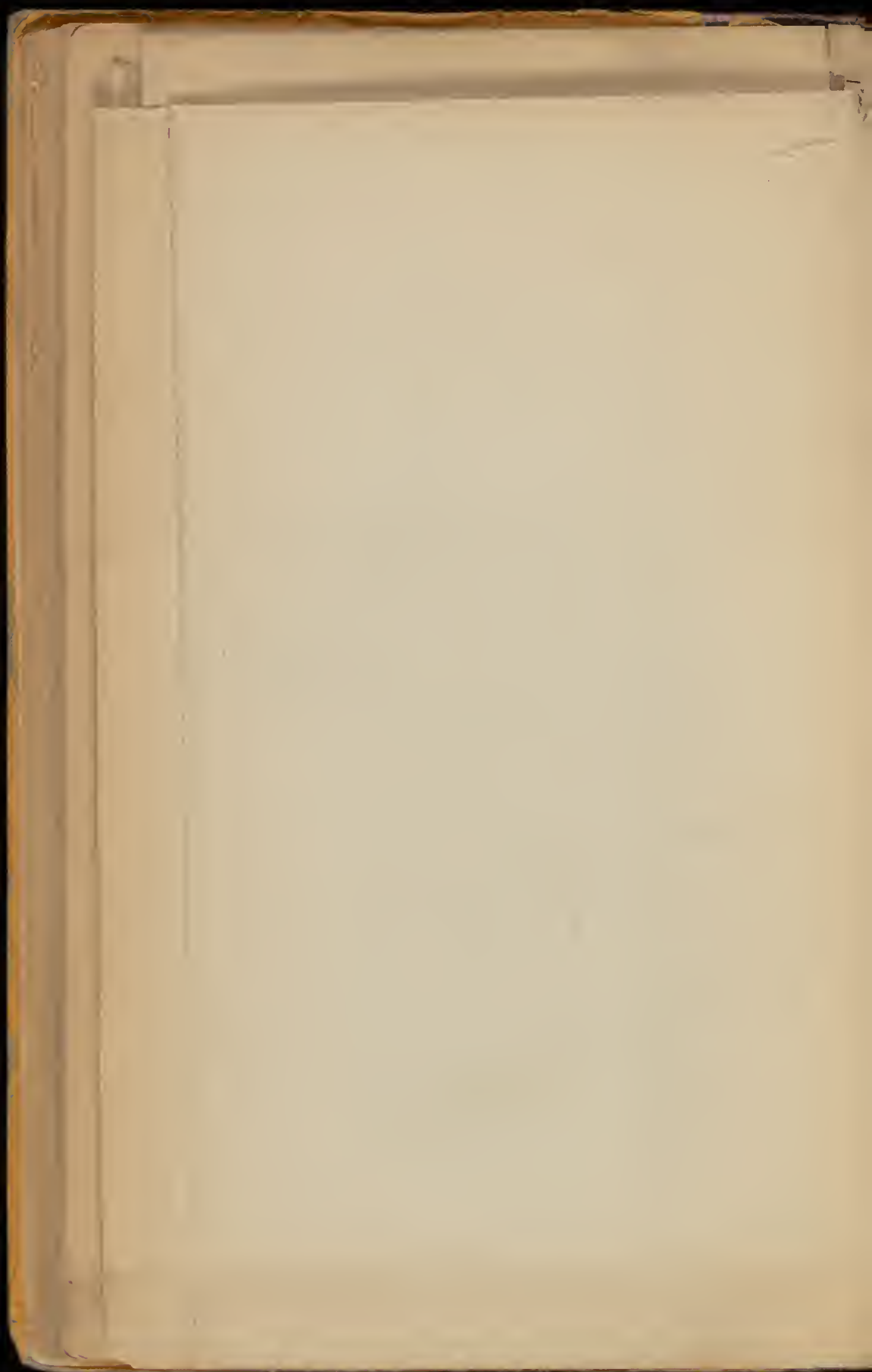

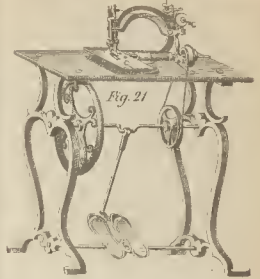
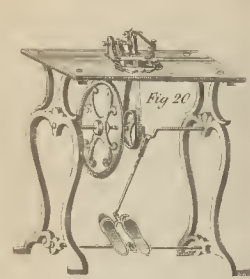
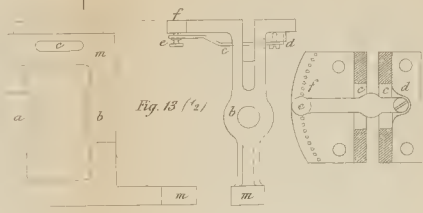
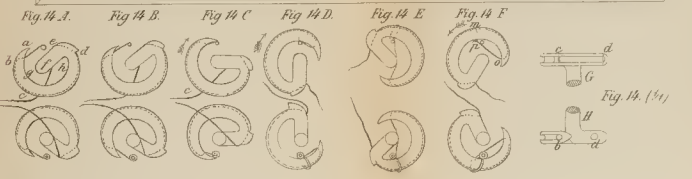
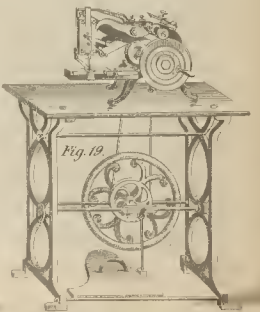
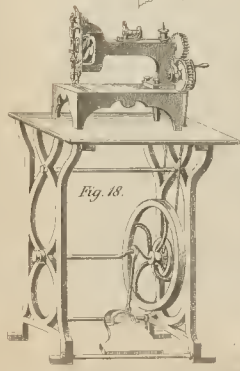
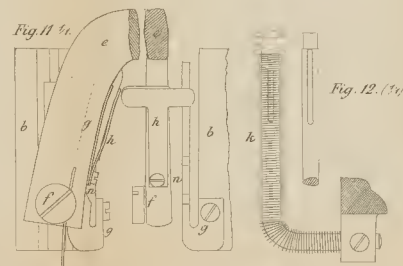
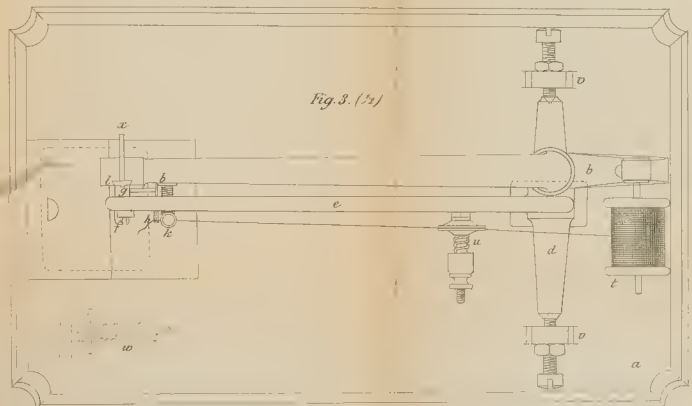
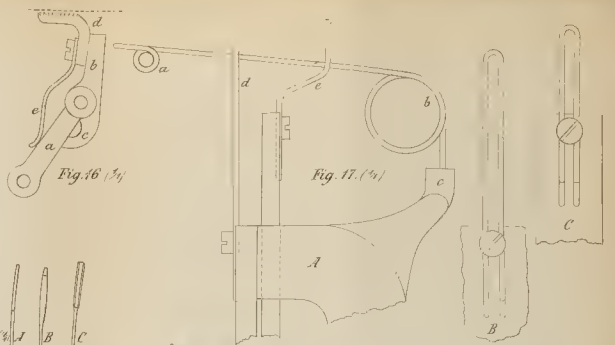
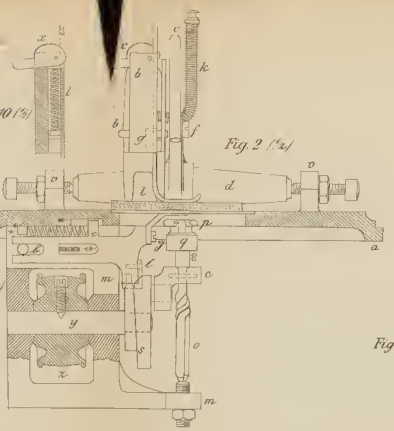
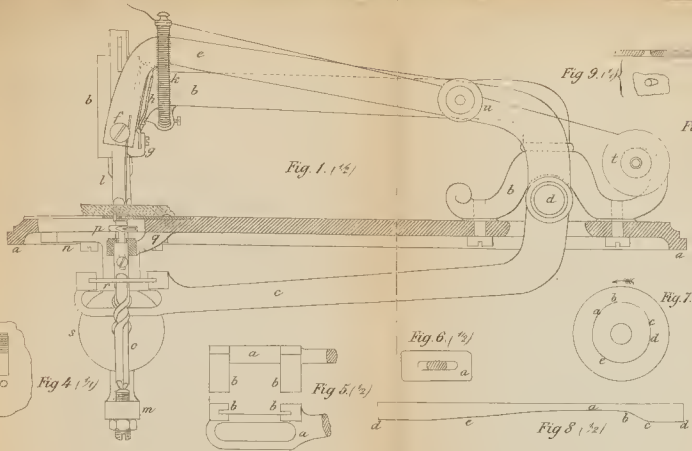

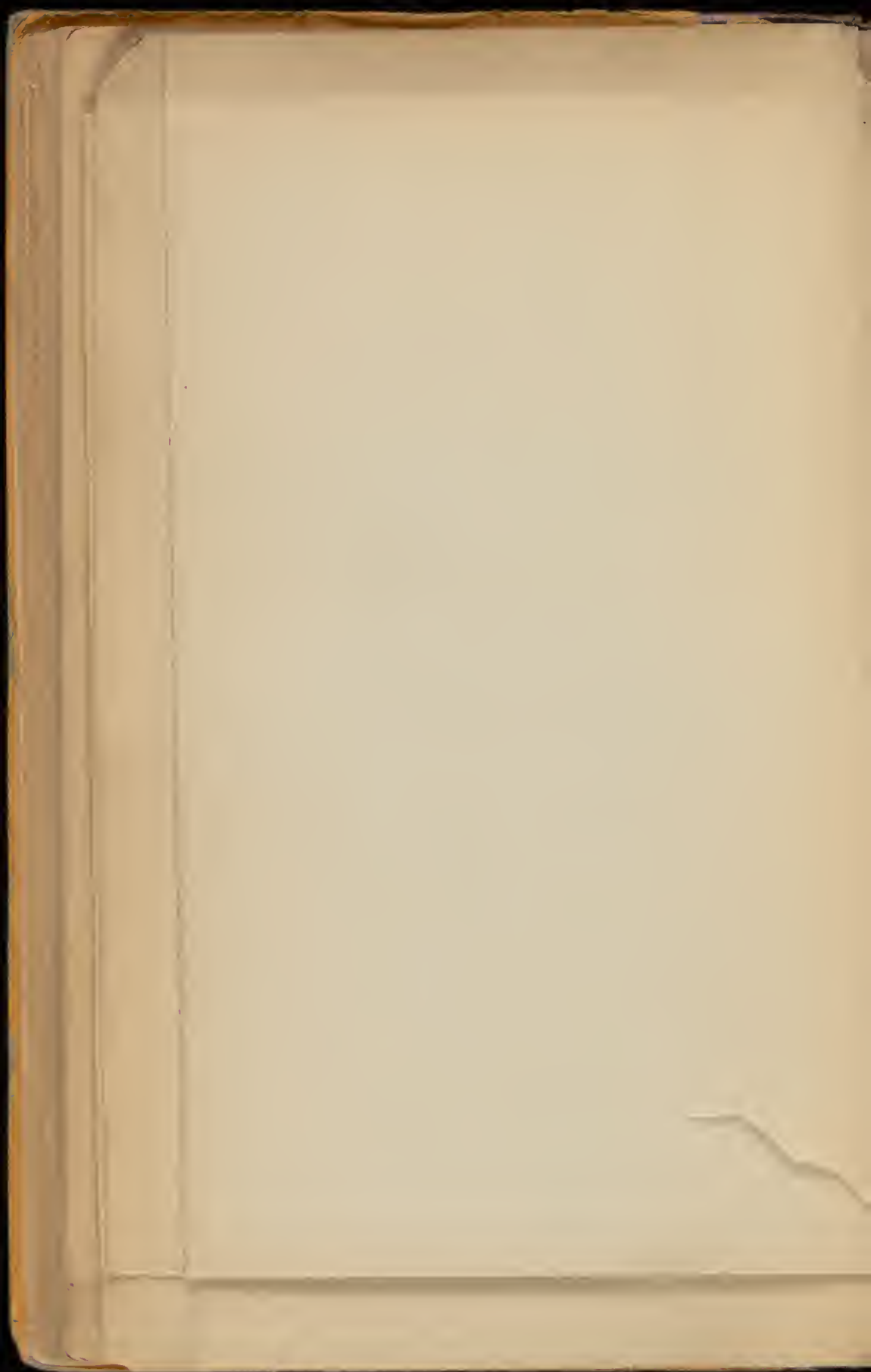

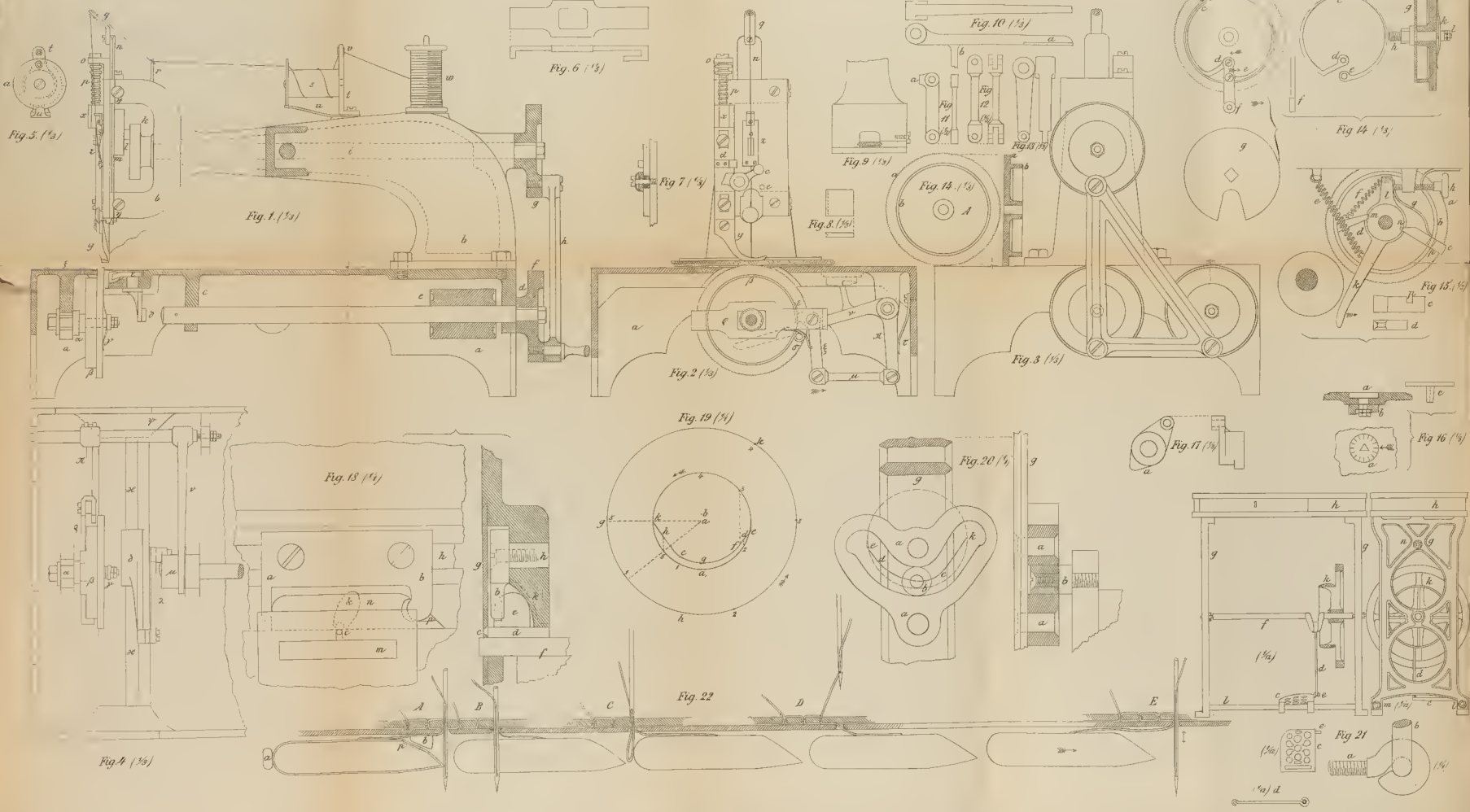

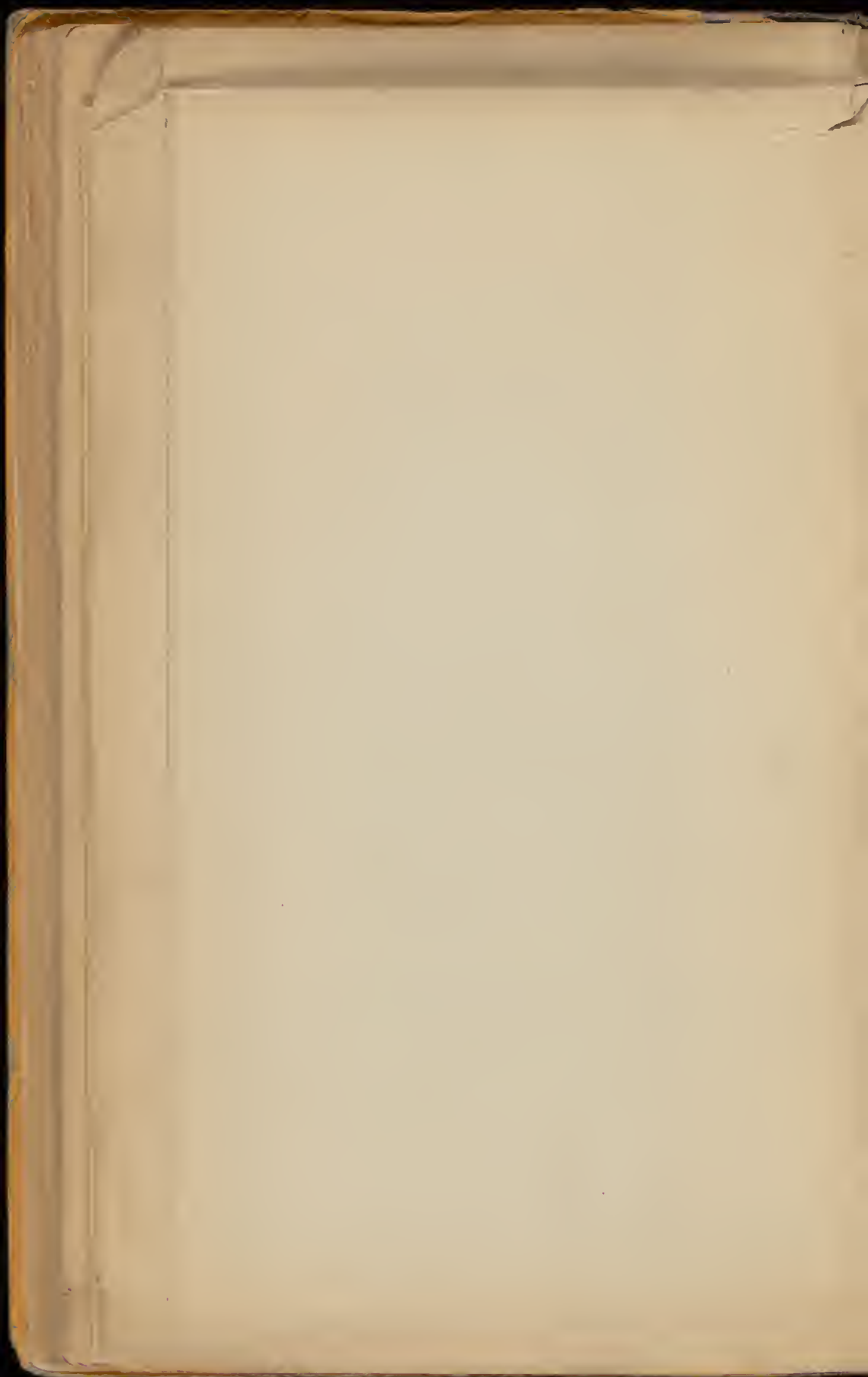

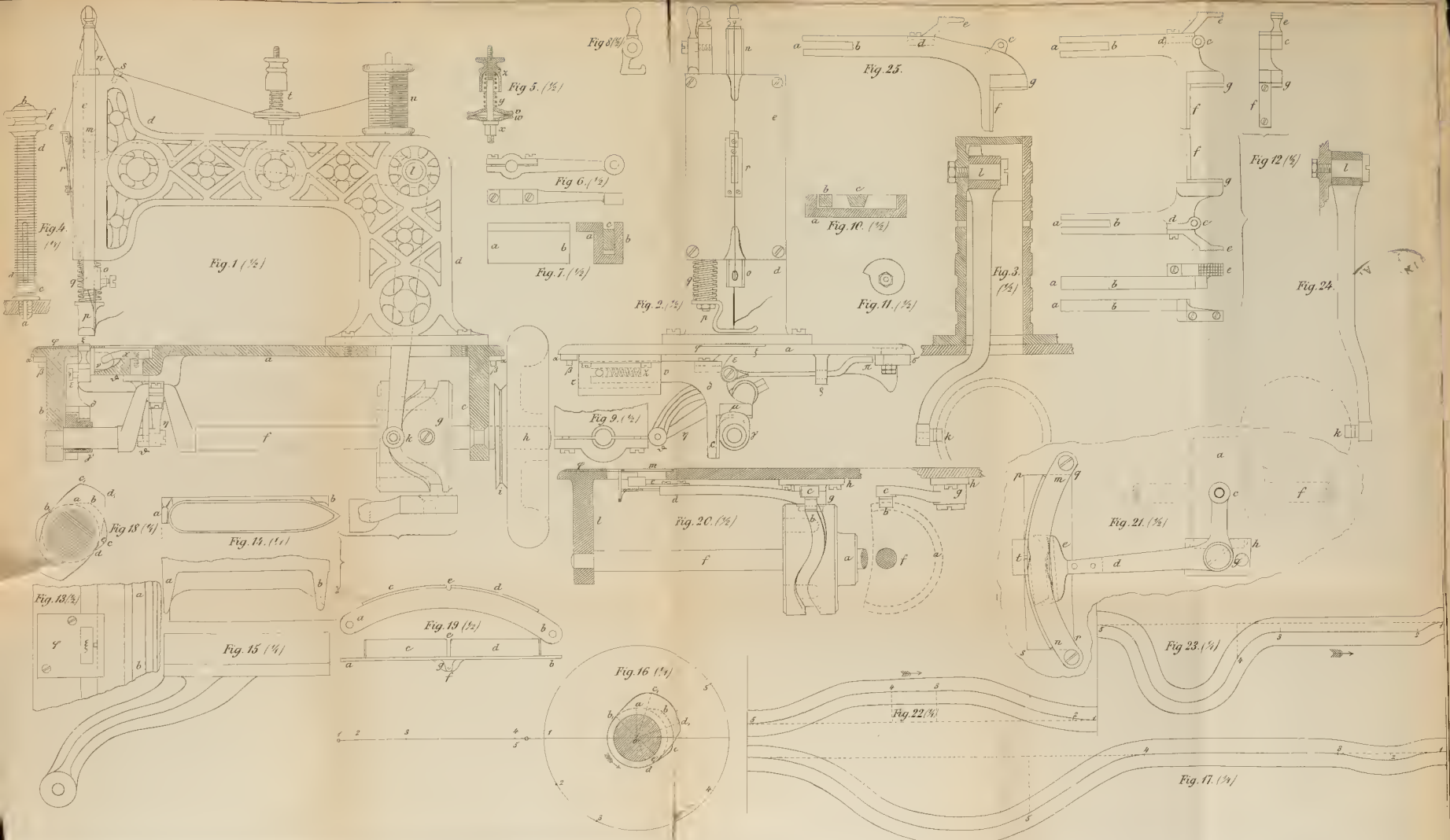

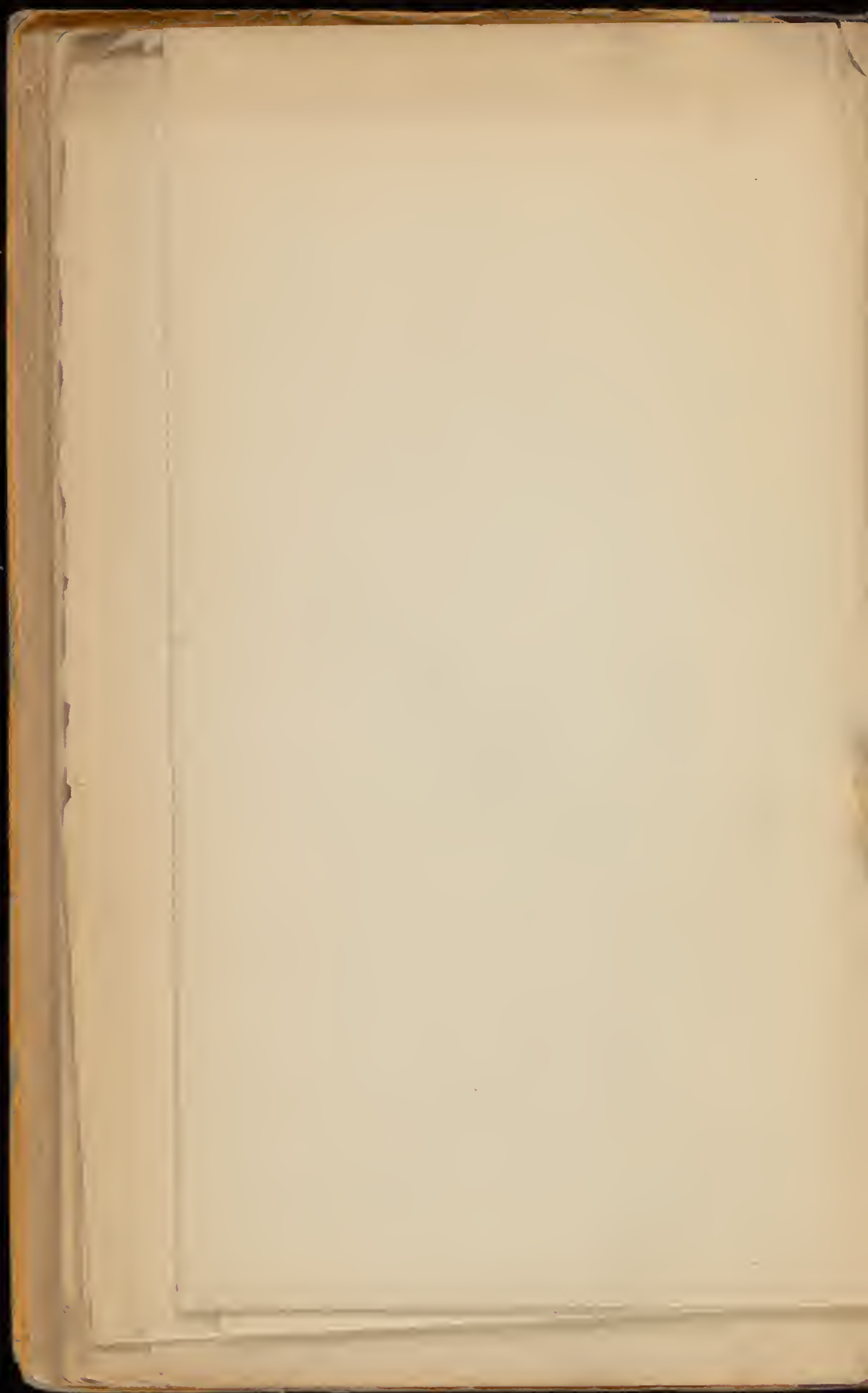

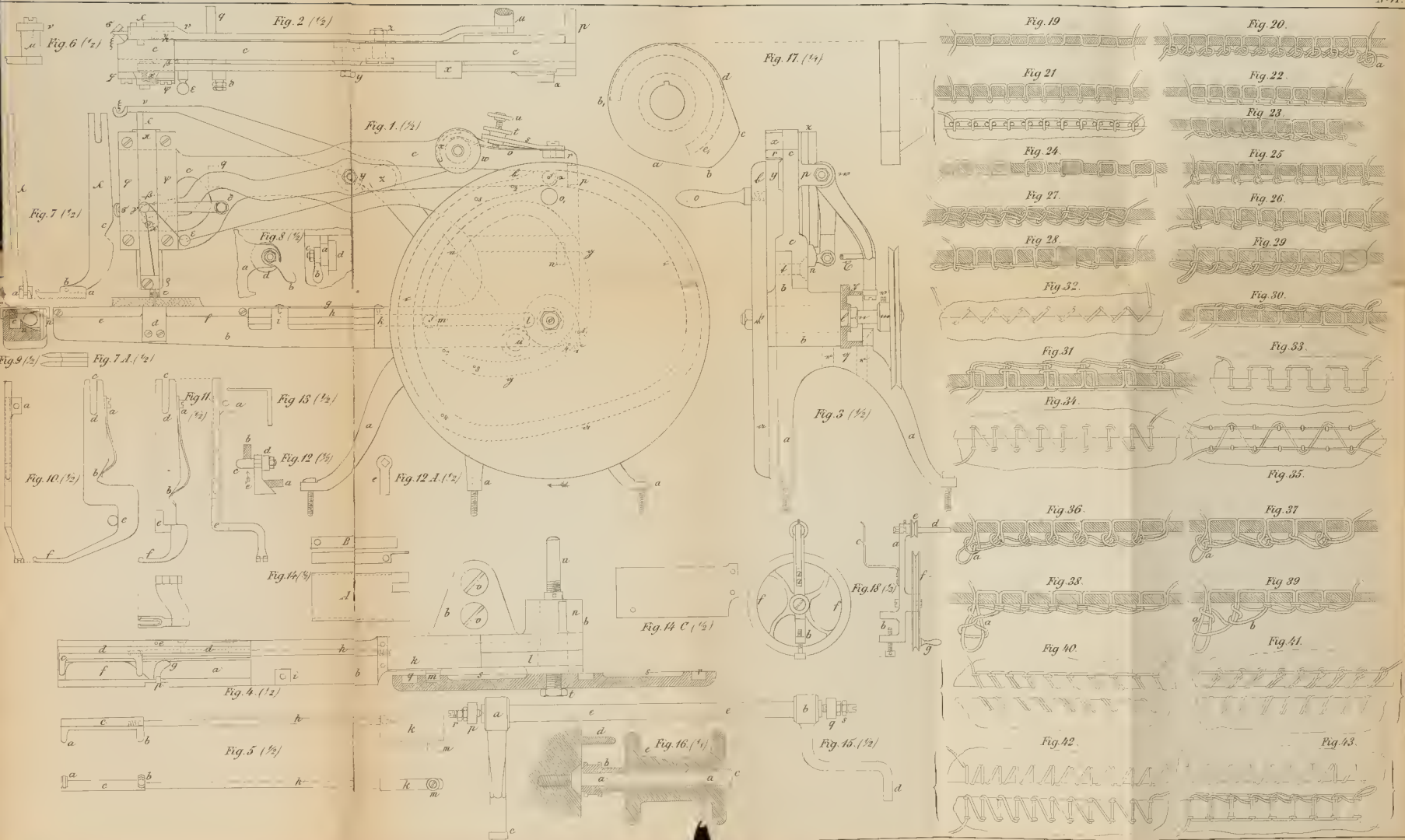

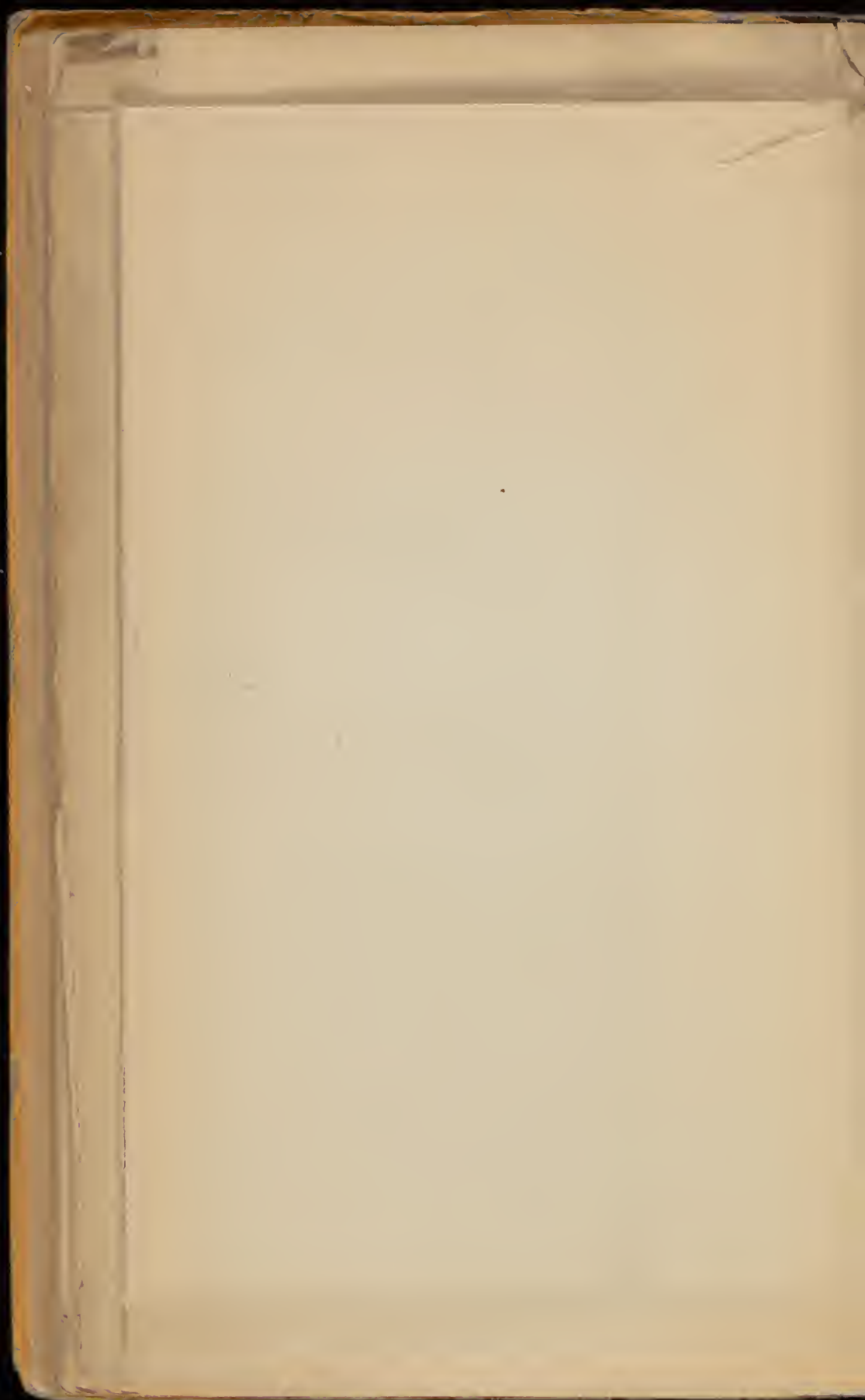

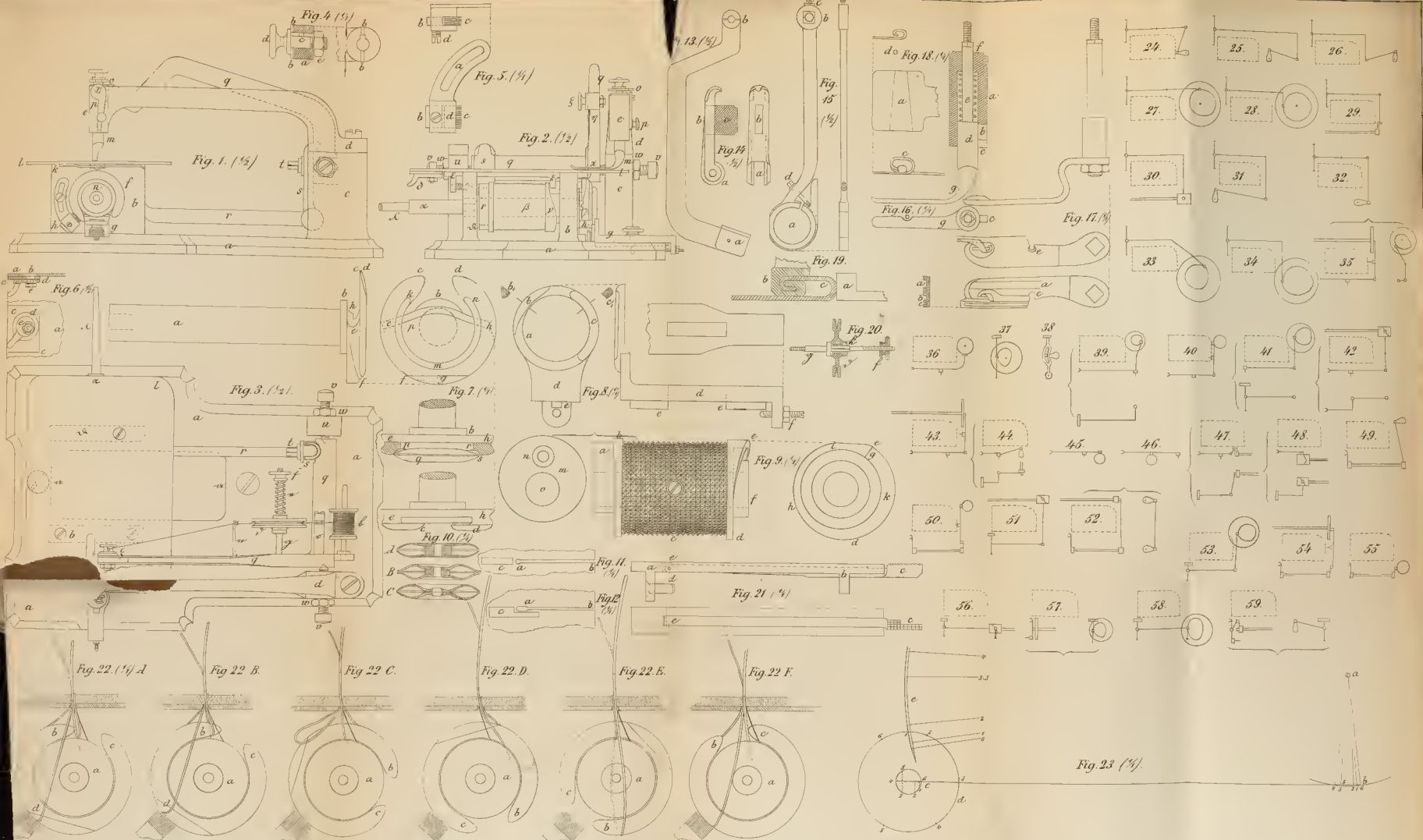

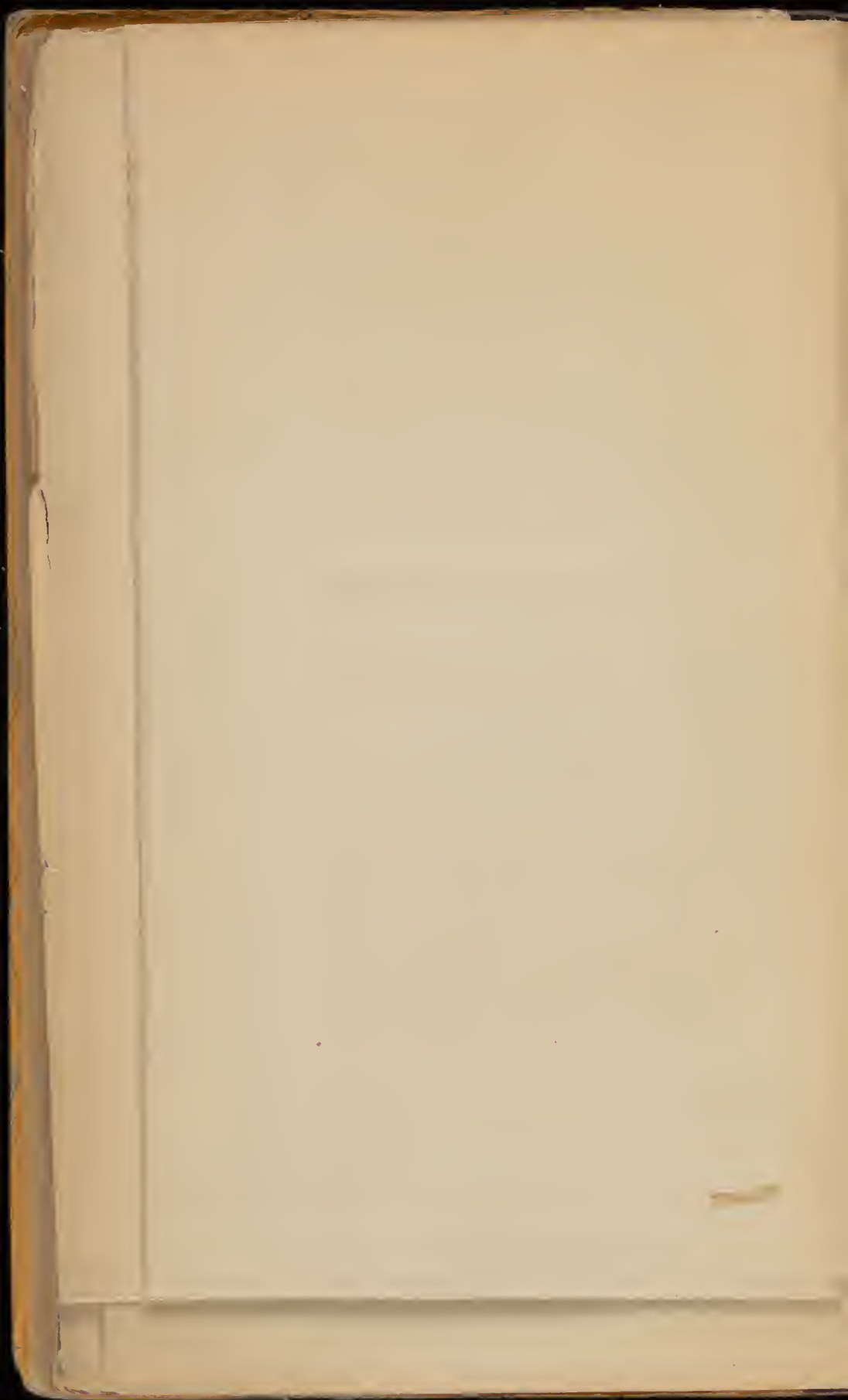

LIST OF BOOKS

PUBLISHED BY

E. & F. N. SPON

16, BUCKLESBURY, LONDON.



ARCHITECTURAL SURVEYORS HAND BOOK.—

A Hand-book for Architectural Surveyors, and others engaged in Building, by J. T. Hurst, C.E., royal 32mo, roan, 4s. 6d.

BIRT (W. R.)—

The Manifestation and Operation of Volcanic Forces in modifying the Moon's surface, by W. R. Birt, F.R.A.S., 12mo, sewed 6d.

BREWING.—

Instructions for making Ale or Beer in all temperatures, especially adapted for Tropical Climates, by John Beadel, on a sheet, 6d.

CHALMERS TARGET (The).—

England's Danger, The Admiralty Policy of Naval Construction, by James Chalmers, 8vo, sewed, 2s.

CHANNEL RAILWAY (The).—

Connecting England and France, by James Chalmers, plates, royal 8vo, cloth, 3s. 6d.

COTTAGES.—

Designs for Schools, Cottages, and Parsonage Houses for Rural Districts, by H. Weaver, fol., half-bound, 7s. 6d.

CHOCOLATE AND COCOA.—

Cocoa; its growth and Culture, Manufacture, and Modes of Preparation for the Table, Illustrated with engravings, accompanied by easy methods of analysis, whereby its purity may be ascertained, by Charles Hewett, post 8vo, price 1s.

LIST OF BOOKS PUBLISHED BY

COFFEE AND CHICORY.—

Coffee and Chicory: their culture, chemical composition, preparation for market, and consumption, with simple tests for detecting adulteration and practical hints for the producer and consumer, by P. L. Simmons, F.S.S., Author of "The Commercial Products of the Vegetable Kingdom," "Dictionary of Trade Products, &c. &c. &c., post 8vo, sewed, 1s.

COTTON CULTIVATION.—

Cotton Cultivation in its various details, the Barrage of Great Rivers, and Instructions for Irrigating, Embanking, Draining, and Tilling Land in Tropical and other Countries possessing high thermometric temperatures, especially adapted to the improvements of the cultural soils of India, by Joseph Gibbs, Member Institute Civil Engineers, with 5 plates, crown 8vo, cloth, 7s. 6d.

COTTON SUPPLY.—

Considerations relative to Cotton Supply, as it was, as it is, and as it might be, by Joseph Gibbs, Member Institute Civil Engineers, 8vo, sewed, 1s.

EARTHWORK TABLES.—

A general sheet Table for facilitating the Calculation of Earthworks for Railways, Canals, &c., by F. Bashworth, M.A., on a large sheet, 6d.

EARTHWORK TABLES.—

A general Table for facilitating the Calculation of Earthworks for Railways, Canals, &c., with a Table of Proportional Parts, by Francis Bashworth, M.A., Fellow of St. John's College, Cambridge, in 8vo, cloth, with mahogany slide, 4s.

"This little volume should become the hand-book of every person whose duties require even occasional calculations of this nature; were it only that it is more extensively applicable than any other in existence, we could cordially recommend it to our readers, but when they learn that the use of it involves only half the labour of all other Tables constituted for the same purpose, we offer the strongest of all recommendations, that founded on the value of time."—*Mechanics' Magazine*.

ELECTRICITY.—

A Treatise on the Principles of Electrical Accumulation and Conduction, by F. C. Webb, Associate Institute Civil Engineers, part I, crown 8vo, cloth, 3s. 6d.

E. & F. N. SPON, 16, BUCKLESBURY, LONDON.

ELECTRICITY.—

Scientific Researches, experimental and theoretical in Electricity, Magnetism, Galvanism, Electro-Magnetism, and Electro-Chemistry, illustrated with engravings, by William Sturgeon, royal 4to, cloth, 21s.

ELECTRO-METALLURGY.—

Contributions towards a History of Electro-Metallurgy, establishing the Origin of the Art, by Henry Direks, crown 8vo, cloth, 4s.

ENGINEERS' POCKET BOOK.—

A Pocket Book of useful Formulæ and Memoranda for Civil and Mechanical Engineers, by Guildford L. Molesworth, Member Institute Civil Engineers, Chief Resident Engineer Ceylon Railway, sixth edition, with a supplement, royal 32mo, roan, 4s. 6d.; the supplement can be had separate, price 3d.

"Mr. Molesworth has done the profession a considerable and lasting benefit by publishing his very excellent Pocket-Book of Engineering Formulæ. What strikes us first, is, the very convenient size and form of the book adopted by the author, and next in glancing over its contents we are pleased to find many really useful things not found elsewhere in any Engineering Pocket-Book. Mr. Molesworth's treatment of Hydraulics and Hydro-Dynamics, and Motive Power, generally, is excellent. To the latter branch of his subject, Mr. Molesworth has evidently devoted considerable attention, and his collection of formulæ will be found most useful. But to stop to detail everything that is good and useful in this book would be nearly equal to re-printing a list of its contents."—*Artizan*, April, 1863.

ENGINEERS' PRICE BOOK.—

Appleby's Illustrated Hand-book and Prices current of Machinery and Iron Work, with various useful Tables of Reference, compiled for the use of Engineers, Contractors, Builders, British and Foreign Merchants, &c., 8vo, cloth, 2s. 6d.

FRENCH CATHEDRALS.—

French Cathedrals, by B. Winkles, from drawings taken on the spot, by R. Garland, Architect, with an historical and descriptive account, 50 plates, 4to, cloth, 18s.

LIST OF BOOKS PUBLISHED BY

GLACIERS.—

Expeditions on the Glaziers, including an ascent of Mont Blanc, Monte Rosa, Col du Géant, and Mont Buét, by a Private of the 38th Artists, and Member of the Alpine Club, post 8vo, sewed, 2s.

GOLD-BEARING STRATA.—

On the Gold-bearing Strata of Merionethshire, by T. A. Readwin, F.G.S., 8vo, sewed, 6d.

HEAT.—

An enquiry into the Nature of Heat, and into its Mode of Action in the Phænomena of Combustion, Vaporisation, &c., by Zerah Colburn, 8vo. boards, 2s.

HYDRAULICS.—

Tredgold's Tracts on Hydraulics, containing Smeaton's experimental Papers on the Power of Water and Wind to turn Mills, &c., &c., Venturi's Experiments on the Motion of Fluids, and Dr. Young's Summary of Practical Hydraulics, plates, royal 8vo, boards, reduced to 6s.

IRON BRIDGES.—

Diagrams to facilitate the Calculation of Iron Bridges, by Francis Campin, C.E., folded in 4to, wrapper, 2s. 6d.

IRON BRIDGES.—

A practical Treatise on Cast and Wrought Iron Bridges and Girders as applied to Railway Structures and to Buildings generally, with numerous examples drawn to a large scale, selected from the Public Works of the most eminent Engineers, with 58 full-page plates, by William Humber, Associate Institute Civil Engineers, and Member of the Institution of Mechanical Engineers, imperial 4to, half bound in Morocco, £1 16s.

"Mr. Humber's admirable work on Iron Bridges."—*The Times*.

IRON (APPLICATION OF).—

Two Lectures on Iron, and its application to the manufacture of Steam Engines, Millwork, and Machinery, by William Fairbairn, C.E., F.R.S., demy 8vo, sewed, 1s.

LIST OF BOOKS PUBLISHED BY

JONATHAN HULLS.—

A description and draught of a new invented Machine for carrying Vessels or Ships out of or into any Harbour, Port, or River, against Wind and Tide, or in a calm, by Jonathan Hulls, 1737, reprint in fac-simile, 12mo, half morocco, reduced to 2s. sewed 1s.

LIFE CONTINGENCIES.—

A brief View of the Works of the earlier eminent writers on the doctrine of Life Contingencies, by Thomas Carr, 8vo, sewed, 1s.

LOCKS AND SAFES.—

A Treatise on Fire and Thief-proof Depositories and Locks and Keys, by George Price, in one large vol. (916 pages), with numerous wood-engravings, 8vo, cloth, gilt, 5s.

LOCKS AND SAFES.—

A Treatise on Gunpowder-proof Locks, Gunpowder-proof Lock Chambers, Drill-proof Safes, Burglars' methods of opening Iron Safes, and the various methods adopted to prevent them; why one maker's safes are better than another's; the Burnley Test, its history and results, by George Price, author of "A Treatise on Fire and Thief-proof Depositories and Locks and Keys," demy 8vo, cloth, with 46 wood engravings, 1s.

MARINE STEAM ENGINE.—

A Catechism of the Marine Steam Engine, for the use of young Naval Officers and others, by Thomas Miller, Captain R.N., F.R.G.S., F.S.A., 12mo, cloth, 2s.

MECHANICAL DRAWING.—

An elementary Treatise on Orthographic Projection, being a new method of teaching the Science of Mechanical and Engineering Drawing, intended for the instruction of Engineers, Architects, Builders, Smiths, Masons, and Bricklayers, and for the use of Schools, with numerous illustrations on wood and steel, by William Binns, Associate Institute Civil Engineers, late Master of the Mechani-

E. & F. N. SPON, 16, BUCKLESBURY, LONDON.

cal Drawing Class at the Department of Science and Art, and at the School of Mines, formerly Professor of Applied Mechanics at the College for Civil Engineers, &c., third edition, 8vo, cloth, 9s. Mr. Binns' system of Mechanical Drawing is in successful operation in all the Art Schools of the United Kingdom.

"Mr. Binns has treated his subject in a practical and masterly manner, avoiding theoretical disquisitions on the art, and giving direct and applicable examples, advancing progressively from the correct orthographic projection of the most simple to the most complex forms, thus clearing away the mist from the mind of the student, and leading him gradually to a correct and thorough appreciation of what he has undertaken, and to that which it is his desire to attain."—*The Artizan*.

MEMOIRS OF SCIENTIFIC MEN.—

Memoirs of the Distinguished Men of Science of Great Britain, living A.D. 1807-8, by H. Walker jun., with an Introduction by Robert Hunt, F.R.S., second edition, revised and enlarged, post 8vo, cloth, 4s. 6d.

MINING.—

A Practical Treatise on Mine Engineering, by G. C. Greewell, 61 plates, royal 4to, half bound, £2 15s.

MINING.—

Records of Mining and Metallurgy, or Facts and Memoranda for the use of the Mine Agent and Smelter, by J. Arthur Phillips and John Darlington, in crown 8vo, cloth, illustrated by wood engravings by F. Delamotte, reduced to 4s., in boards, 3s.

MINING.—

A Treatise on the Ventilation of Coal Mines, together with a Narrative of Scenes and Incidents in the Life of a Working Miner, by Robert Scott, 8vo, sewed, 1s.

OBLIQUE BRIDGES.—

A practical Treatise on the Construction of Oblique Bridges with spiral and with equilibrated courses, with 12 plates, containing 100 figures, by Francis Bashforth, M.A., Fellow of St. John's College, Cambridge, 8vo, cloth, 6s.

LIST OF BOOKS PUBLISHED BY

OPTICAL ILLUSIONS.—

The Ghost as produced in the Spectre Drama, popularly illustrating the marvellous optical illusions, obtained by the apparatus called the Dirksian Phantasmagoria, by Henry Dircks, C.E., crown 8vo, cloth, 2s.

ORNAMENT.—

The book of Ornaments of every style, applicable to Art and Industry, for the use of Lithographers, Engravers, Silversmiths, Decorators, and other Art-Workmen, by Jos. Scheidel, 5 numbers at 1s. 6d. each.

ORNAMENT.—

Gleanings from Ornamental Art of every style, drawn from examples in the British, South Kensington, Indian, Crystal Palace, and other Museums, the Exhibitions of 1851 and 1862, and the best English and Foreign Works, in a series of 100 plates containing many hundred examples, by R. Newberry, 4to, cloth, 30s.

PERPETUAL MOTION.—

Perpetuum Mobile, or Search for Self-motive power during the 17th, 18th, and 19th centuries, illustrated from various authentic sources in papers, essays, letters, paragraphs, and numerous patent specifications, with an introductory essay by Henry Dircks, C.E., with numerous engravings of machines, crown 8vo, cloth, 10s. 6d.

"A curious and interesting work. Mr. Dircks' chief purpose was to collect together all the materials requisite to form a record of what has been done, or attempted, rather in this curious branch of *quasi* science, and most instructive in one sense it is. Mr. Dircks' volume is well worth looking into; it contains a vast deal of entertaining matter."—*Builder*.

RAILWAYS.—

Railway Practice, a collection of working plans and practical details of construction in the Public Works of the most celebrated Engineers, comprising Roads, Tramroads and Railways, Bridges, Aqueducts, Viaducts, Wharfs, Warehouses, Roofs and Sheds, Canals, Locks, Sluices, and the various

LIST OF BOOKS PUBLISHED BY

Piers and Jetties, Tunnels, Cuttings, and Embankments, Works connected with the Drainage of Marshes, Marine Sands, and the Irrigation of Land, Water Works, Gas-works, Water-wheels, Mills, Engines, &c., by S. C. Brees, C.E. Text in 4to, with 279 plates in folio, together 2 vols. half-bound morocco, £3 10s.

RAILWAY MASONRY.—

The Guide to Railway Masonry, containing a complete Treatise on the Oblique Arch, by Peter Nicholson, third edition, revised by R. Cowen, C.E., with 42 plates, 8vo, cloth, 9s.

ROPEMAKING.—

A Treatise on Ropemaking as practised in public and private Rope-yards, with a description of the manufacture, rules, tables of weights, &c., adapted to the Trade, Shipping, Mining, Railways, Builders, &c., by R. Chapman, formerly foreman to Messrs. Huddart and Co., Limehouse, and late Master Rope Maker of H.M. Dockyard, Deptford, 18mo, cloth, 2s.

SCREW CUTTING.—

Screw Cutting Tables for the use of Mechanical Engineers, showing the proper arrangement of Wheels for cutting the threads of screws of any required pitch, with a Table for making the Universal Gas Pipe Threads and Taps, by W. A. Martin, Engineer, royal 8vo, oblong, cloth, 1s., sewed, 6d.

SCREW PROPELLER.—

The Screw Propeller, what it is, and what it ought to be, by R. Griffith, 8vo, sewed, 6d.

SEWING MACHINE.—

The Sewing Machine: its History, Construction, and Application, translated from the German of Dr. Herzberg, by Upfield Green, illustrated by 7 large lithographic plates, royal 8vo, ornamental boards, 7s. 6d.

SOCIETY OF ENGINEERS.—

Transactions of the Society of Engineers, 1860 to 1862, plates, 12mo, sewed, 7s. 6d. The volume for 1863, just ready, cloth.

LIST OF BOOKS PUBLISHED BY

STEAM BOILERS.—

The Modern Practice of Boiler Engineering, containing observation on the Constructions of Steam Boilers, and remarks upon Furnaces, used for Smoke Prevention, with a chapter on Explosions, by Robert Armstrong, C.E., revised with the addition of Notes and an Introduction by John Bourne, Esq., with engravings, fcap. 8vo, cloth, 2s.

“The collected experience of a practical Engineer, who, for thirty years of his life has directed his attention to the construction of Steam-Boilers and Furnaces, is a valuable addition to the stock of Engineering knowledge, and it will be generally more appreciated because it is condensed within so small a volume as the one before us.”—*Civil Engineer and Architects' Journal*.

STEAM BOILERS.—

Steam Boiler Explosions, by Zerah Colburn, 8vo, sewed, 1s.

STEAM ENGINE.—

Practical illustrations of Land and Marine Engines, shewing in detail all the modern improvements of High and Low Pressure, Surface Condensation, and Super-heating, together with Land and Marine Boilers, by N. P. Burgh, Engineer, 20 plates in double elephant, folio, cloth, with text. £2 2s.

STEAM ENGINE.—

Rules for Designing, Constructing and Erecting Land and Marine Engines and Boilers, by N. P. Burgh, Engineer, Royal 32mo, roan, 4s. 6d.

STEAM ENGINE.—

The Steam Engine, for Practical Men, containing a theoretical investigation of the various rules given in the work, and several useful Tables, by James, Hann, A.I.C.E., and Placido and Justo Gener, Civil Engineers, 8vo, cloth, 9s.

“To the practical and scientific Engineer, and to the Assistant Engineer, who aspires to pass his examination for chief with credit to himself, and the Service, we can cordially recommend the work.”—*The Nautical Standard*.

F. N. SPON, 16, BUCKLESBURY, LONDON.

STEAM NAVIGATION.—

High-speed Steam Navigation and Steamship Perfection—Can perfection be defined in the form of a Steamship, a Propeller, or any other mechanical contrivance? a proposition for the solution of the Scientific World, and for the consideration of the British Admiralty, by Robert Armstrong, of Poplar, 8vo, sewed, 1s.

SUGAR MACHINERY.—

A Treatise on Sugar Machinery, by N. P. Burgh, Engineer, with 16 plates drawn to a large scale, royal 4to, cloth, 30s.

SURVEYING.—

An Introduction to the present practice of Surveying and Levelling, being a plain explanation of the Subject and of the instruments employed, illustrated with suitable plans, sections, and diagrams, also with engravings of the Field Instruments, by S. C. Brees, C.E., 8vo, cloth, 3s. 6d.

SURVEYING.—

A practical Treatise on the science of Land and Engineering Surveying, Levelling, estimating quantities, &c., with a general description of the several Instruments required for Surveying, Levelling, Plotting, &c., and Illustrations and Tables, by H. S. Merrett, royal 8vo, cloth, 16s.

TRADE OF NEWCASTLE-ON-TYNE.—

History of the Trade and Manufactures of the Tyne, Wear, and Tees, comprising the papers prepared under the auspices of a Committee of Local Industry, and other documents of a similar character, read at the second meeting in Newcastle-on-Tyne of the British Association for the advancement of Science, revised and corrected by the writers, second edition, 8vo, boards, 3s. 6d.

TURBINE.—

A practical Treatise on the construction of the Turbine or Horizontal Water-wheel, with seven plates specially designed for the use of operative Mechanics, by William Cullen, Millwright and Engineer, 4to, sewed, 6s.

LIST OF BOOKS PUBLISHED BY

TURNING.—

Turners' and Fitters' Pocket-book for calculating the change wheels for screws on a Turning Lathe, and for a Wheel-cutting Machine, by J. La Nicca, 18mo, sewed, 6d.

TURNING.—

The practice of Hand-turning in Wood, Ivory, Shell, &c., with Instructions for turning such works in Metal, as may be required in the practice of Turning in Wood, Ivory, &c.; also, an Appendix on Ornamental Turning, by Francis Campin, with wood engravings, crown 8vo, cloth, 6s.

WAGE TABLE.—

Delany and Okes' Wage Table for Engineers, Shipbuilders, Contractors, Builders, &c., from one-quarter of an hour, in regular progression to nine and three-quarter hours, from one day to ten days, at one shilling to eight shillings per day, on one sheet, 1s.

In 2 vols., royal 8vo, half morocco, neat, price £3 3s.

APPLETON'S
DICTIONARY OF MACHINES,
MECHANICS' ENGINE-WORK, AND ENGINEERING,
WITH 4000 ENGRAVINGS ON WOOD, AND
MANY STEEL PLATES.

SECOND EDITION.

LONDON: E. & F. N. STON, 16, BUCKLERSBURY.

Royal 4to, cloth, Illustrated by 84 Plates of Furnaces and Machinery,
price £3 10s.,

THE IRON MANUFACTURE OF GREAT BRITAIN.

THEORETICALLY AND PRACTICALLY CONSIDERED ;
Including Descriptive Details of the Ores, Fuels, and Fluxes, employed ;
the Preliminary Operation of Calcination ; the Blast, Refining and
Puddling Furnaces ; Engines and Machinery ; and the various Pro-
cesses in Union, &c.

By WILLIAM TRURAN, C.E.,

Formerly Engineer at the Dowlais Iron Works, under the late Sir John Guest, Bart.
subsequently at the Hirwain and Forest Works, under Mr. Crawshaw.

SECOND EDITION.

Revised from the Manuscript of the late Mr. W. Truran,

By J. ARTHUR PHILLIPS,

Author of "A Manual of Metallurgy," "Records of Mining," &c. ;

AND

W. H. DORMAN, C.E.

OPINIONS OF THE PRESS.

"The book treats of every detail connected with the arrangement, erection, and practical management of Iron Works, in the most minute and careful manner ; and the various ores and the materials employed in reducing the ores, and in producing the metal in its various stages up to the finished metal—in the form of Rails, Merchant Bars, Rods, Hoops, and Plates—are most thoroughly and scientifically dealt with, and in the most intelligible manner brought before the reader."—*Artizan*, October, 1862.

"The most complete and practical treatise upon the Metallurgy of iron to be found in the English language."—*Colliery Guardian*, November 29, 1862.

"Mr. Truran's work is really the only one deserving the name of a treatise upon, and text-book of the Iron Manufacture of the Kingdom. It gives a most comprehensive and minute exposition of present practice, if the term may be applied to Iron Manufacture as distinguished from strictly professional subjects. The Author does not go out of his way to theorise how Iron should or may be made, but he describes how it is made in all the Iron Districts of the Kingdom."—*Engineer*, December 26, 1862.

"It has seldom fallen to our lot to introduce to the notice of the scientific public, a more valuable work than this. It is evidently the result of long, careful, and practical observation, and it forms at once a glorious monument to the memory of its author, and an excellent guide to those who are directly and indirectly interested in the great subject of which it treats."—*Mechanics' Magazine*, Sept. 26, 1862.

"To the valuable character of Mr. Truran's work, we fully referred upon the publication of the first edition, and we cannot say more in praise of the very handsome volume before us, than that whatever information was wanted in the former has now been carefully supplied, and that the whole work appears to have been subjected to an amount of careful revision which has rendered it as near as may be perfect, and consequently gives it a just claim to the highest position as a standard work upon the Metallurgy of the Metal of which it treats. Scientific knowledge and practical experience have been brought to bear in its production, and all the valuable elements of each have been most judiciously combined."—*Mining Journal*, September 20, 1862.

London: E. and F. N. SPON, 16, Bucklersbury.

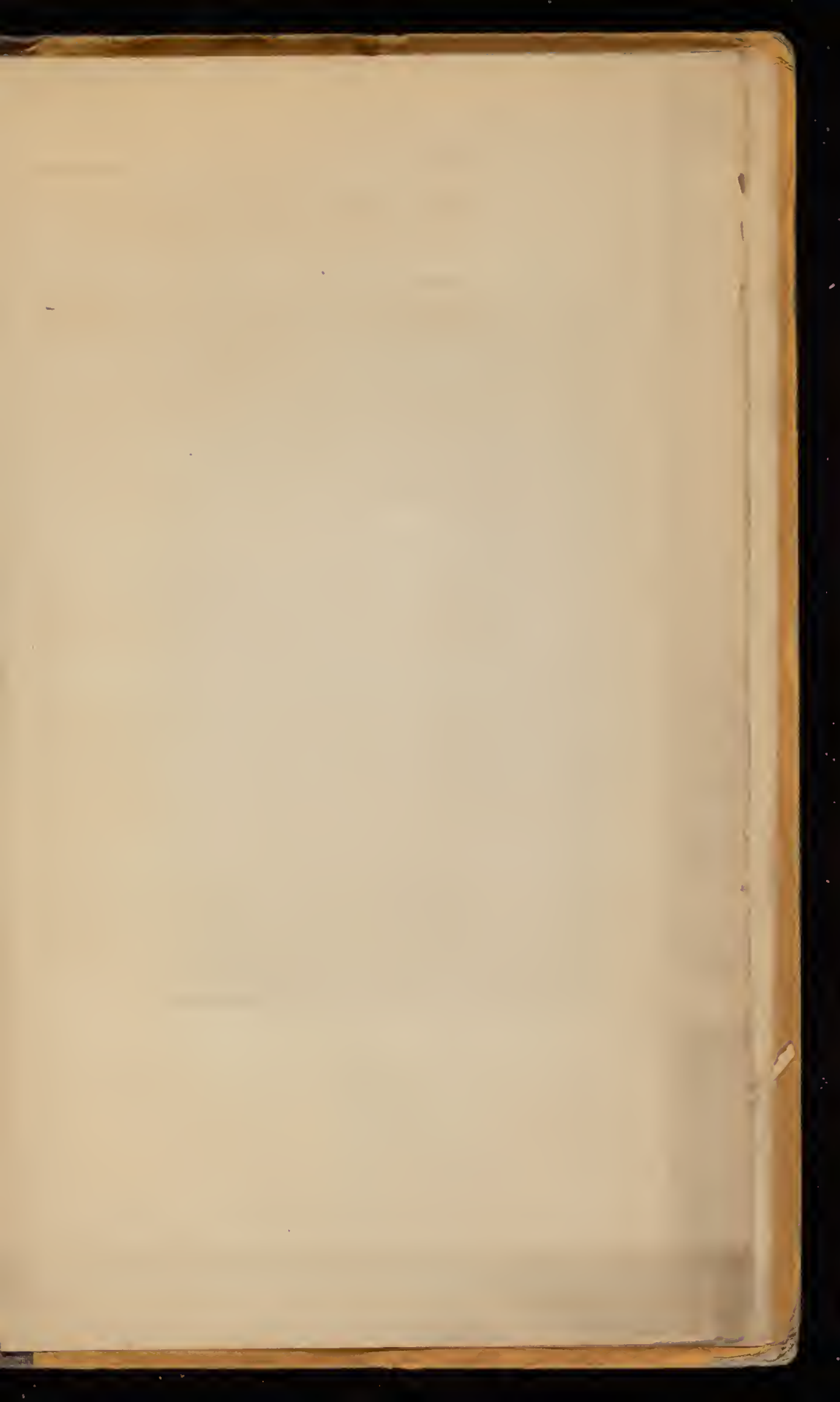

687

H445

2335

687

H445

Third edition, 8vo, cloth, price 9s.,

ILLUSTRATED WITH NUMEROUS ENGRAVINGS ON STEEL AND WOOD,

N ELEMENTARY TREATISE ON ORTHOGRAPHIC PROJECTION;

BEING A NEW METHOD OF TEACHING

The Science of Mechanical and Engineering Drawing,

INTENDED FOR THE INSTRUCTION OF ENGINEERS, ARCHITECTS, BUILDERS, SMITHS, MASONS,
AND BRICKLAYERS, AND FOR THE USE OF SCHOOLS.

By WILLIAM BINNS,

Assoc. Inst. C.E.;

Late Master of the Mechanical Drawing Class at the Department of Science and Art, and at the Government School of
Mines; formerly Professor of Applied Mechanics at the College for Civil Engineers.

LONDON: E. & F. N. SPON, 16, BUCKLESBURY.

OPINIONS OF THE PRESS.

An Elementary Treatise on Orthographic Projection: being a New Method of teaching the Science of Mechanical and Engineering Drawing. By William Binns, Assoc. Inst. C.E.

How many authors of a "Guide to Perspective Drawing," "A Practical Draughtsman's Book of Industrial Designs," "An Engineer and Machinist's Drawing Book," or "Complete Hand-Book to Orthographic Projection," profess to thoroughly elucidate and make plain to the meanest capacity the principles and practice of orthographic, or the conical projection, of solid bodies, but how few of all this profession do so thoroughly! We read in Mr. Binns, the author of the present "Elementary Treatise on Orthographic Projection," in a most able and scientific manner, the practical illustrations of education, and the lessons at the Government School of Mines, and the part of the book which he has written in this subject is a most practical and masterly manual, containing theoretical disquisitions on the art, and giving direct and applicable examples, advancing progressively from the correct orthographic projection of the most simple to the more complex forms, thus clearing away the mist from the mind of the student, and leading him gradually to a correct and thorough appreciation of what he has undertaken, and to that which it is his desire to attain.

Mr. Binns has treated this subject in a practical and masterly manner, containing theoretical disquisitions on the art, and giving direct and applicable examples, advancing progressively from the correct orthographic projection of the most simple to the more complex forms, thus clearing away the mist from the mind of the student, and leading him gradually to a correct and thorough appreciation of what he has undertaken, and to that which it is his desire to attain.

We trust Mr. Binns will follow out the design which he has commenced and announced in the present work by applying his system of treatment to the more advanced subjects for delineation by orthographic projection.—*The Artizan*.

Mr. Binns here undertakes to teach the elements of mechanical and engineering drawing. He very properly insists that, in a subject like this, the student shall make himself master of all preceding parts before proceeding to subsequent portions. The Author's explanations are full and clear, and his book forms one of the best introductions to the study of which it treats that we have met with.—*The Practical Mechanic's Journal*.

The subject of Orthographic Projection, as Mr. Binns expresses it, "the A B C of that description of drawing which is universally adopted as a means of representing all kinds of engineering structures, as well as articles in the process of manufacture."

The present work comprises the Author's course of instruction formerly given at the College of Civil Engineers at Dulwich, and now at the Government Department of Science and Art. It bears throughout evidence of that careful consideration of practical difficulties which was so prominent a feature in teaching the examples of the present work.

Mr. Binns has written a most practical and masterly manual, containing theoretical disquisitions on the art, and giving direct and applicable examples, advancing progressively from the correct orthographic projection of the most simple to the more complex forms, thus clearing away the mist from the mind of the student, and leading him gradually to a correct and thorough appreciation of what he has undertaken, and to that which it is his desire to attain.

worked out, and the work generally shows that the writer has in a high degree that perceptive faculty which often serves instead of systematic study in giving insight into geometrical principles.—*Civil Engineer and Architect's Journal*.

This treatise, by the master of the Mechanical Drawing Class at the Department of Science and Art and at the Government School of Mines, is really a practical work. Engineers may possibly not recognise their ordinary method of delineating machinery under the term "Orthographic Projection," but it is more definite and explanatory than the usual term "Mechanical Drawing." We cannot but commend Mr. Binns' "New Method of Teaching" drawing than in his own words (see Preface, p. v.). The book contains very numerous plates, excellently designed, drawn, and engraved, and arranged so as to unfold quite a course of the book when referred to. We cannot say that the grammatical inaccuracies; in the present work can scarcely be im-

In drawing on educational institutions a more practical character, geometrical drawing must be especially provided for. Looking at Mr. Binns' work (which has just been published), and looking, on the other hand, at our schools of art, mechanics' institutions, and elementary schools, we cannot say that such essential and practical knowledge is adequately inculcated; and yet there is hardly a profession or trade connected with the engineer, the machinist, the architect, the builder, the mason, bricklayer, carpenter, joiner, cabinet maker, which does not absolutely require an acquaintance with the art. In fact, the lower we go the more this knowledge seems imperative, for the lower workmen can better do without writing, if not without reading, than he can without a knowledge of drawing; and to the master it is as essential as either of the other common acquirements. It should be begun at the elementary school, if not it should be taught to adults in special classes.

The author of this work, now spoken of, being a practical draughtsman, in 1846 Professor of Applied Mechanics at the Government School of Civil Engineers at Dulwich, and now at the Government Department of Science and Art. He has been Master of the mechanical drawing class at the Department of Science and Art, and at the Government School of Mines. It is a noteworthy feature in Mr. Binns' book—and we suppose we may say system—that his great endeavour is to do without copying from the "flat," and to bring the student to the practical projection of buildings or machinery.

Of the work, which is practical in character, we have said more fully on another occasion.—*The London News*.